

michael miller FABRICS

# PINEAPPLE PARADISE

SIZE: 63 1/2"W x 83"H • LEVEL: INTERMEDIATE • PATTERN BY: NATALIE CRABTREE • LET'S GET TROPICAL COLLECTION  
PATTERN AVAILABLE ON: WWW.MICHAELMILLERFABRICS.COM



THIS IS A DIGITAL REPRESENTATION OF THE QUILT TOP, FABRIC MAY VARY.

**PLEASE NOTE:** BEFORE BEGINNING YOUR PROJECT, CHECK FOR ANY PATTERN UPDATES AT [MICHAELMILLERFABRICS.COM](http://MICHAELMILLERFABRICS.COM)'S FREE PROJECTS SECTION.

p.212.704.0774 | [info@michaelmillerfabrics.com](mailto:info@michaelmillerfabrics.com) | [www.michaelmillerfabrics.com](http://www.michaelmillerfabrics.com)

# PINEAPPLE PARADISE



**FABRIC A**  
Cotton Couture  
SC\_5333 Cloud  
3 1/2 yards



**FABRIC B**  
CX10894  
Flip Flops White  
1 FQ



**FABRIC C**  
CX10896  
Let's Luau Orange  
1 FQ



**FABRIC D**  
CX10896  
Let's Luau White  
1 FQ



**FABRIC E**  
DCX10892  
Aloha Black  
1 FQ



**FABRIC F**  
DCX10892  
Aloha Green  
1 FQ



**FABRIC G**  
DCX10892  
Aloha Orange  
1 FQ

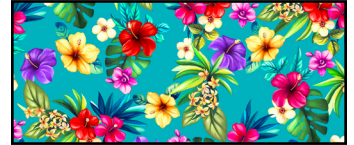

**FABRIC H**  
DCX10892  
Aloha Turquoise  
1 FQ



**FABRIC I**  
DCX10892  
Aloha White  
1 FQ



**FABRIC J**  
DCX10892  
Aloha Yellow  
1 FQ



**FABRIC K**  
DCX10893 Party  
Pineapples Turquoise  
1 FQ



**FABRIC L**  
DCX10893 Party  
Pineapples White  
1 FQ

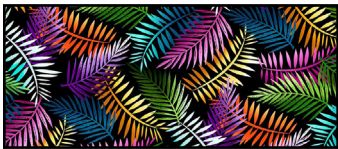

**FABRIC M**  
DCX10898  
Tropical Foliage Black  
1 FQ



**FABRIC N**  
DCX10898  
Tropical Foliage Yellow  
1 1/4 yards  
(includes binding)

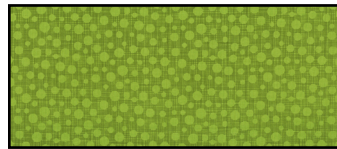

**FABRIC O**  
CX6699 Hash Dot  
Meadow  
5/8 yard

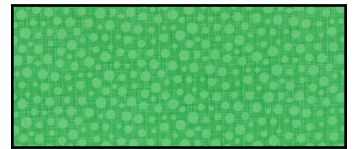

**FABRIC P**  
CX6699 Hash Dot  
Sprout  
3/4 yard

**BACKING:**

5 1/4 yards

**BATTING:**

72" x 91"



# PINEAPPLE PARADISE

WOF = Width of Fabric, RST = Right Sides Together, SNF = Stitch and Flip

Designer Note: Divide the cut pieces by the block type or assembly section specified.

KEY	CUTTING INTRUCTIONS
<b>A</b>	<ul style="list-style-type: none"> <li>• Cut (1) 6 ½" x WOF strip. Subcut the following for the Large Pineapple Block:               <ul style="list-style-type: none"> <li>○ (1) 6 ½" square.</li> <li>○ (2) 6" x 4 ¾" rectangles.</li> </ul> </li> <li>• Cut (1) 5" x WOF strip. Subcut (6) 5" squares for the Large Pineapple Block.</li> <li>• Cut (11) 2 ½" x WOF strips. Subcut the following for the Small Pineapple Blocks:               <ul style="list-style-type: none"> <li>○ (42) 2 ½" x 3" rectangles.</li> <li>○ (126) 2 ½" squares.</li> </ul> </li> <li>• Cut (2) 3 ½" x WOF strips. Subcut (21) 3 ½" squares for the Small Pineapple Blocks.</li> <li>• Cut (2) 15 ½" x WOF strips. Subcut the following for Quilt Assembly:               <ul style="list-style-type: none"> <li>○ (1) 15 ½" x 21 ½" rectangle.</li> <li>○ (2) 15 ½" x 11" rectangles.</li> <li>○ (1) 15 ½" x 12 ½" rectangle.</li> </ul> </li> <li>• Cut (1) 15 ½" x WOF strip. Subcut (17) 15 ½" x 2" sashing rectangles for Quilt Assembly.</li> <li>• Cut (6) 2" x WOF strips. Subcut (22) 2" x 9 ½" sashing rectangles for Quilt Assembly.</li> <li>• Cut (1) 2" x WOF strip. Subcut (19) 2" cornerstone squares for Quilt Assembly.</li> <li>• Cut (8) 1 ½" x WOF strips. Piece (2) strips for length using a diagonal seam. Repeat to make (4) long strips. Subcut the following for Quilt Assembly:               <ul style="list-style-type: none"> <li>○ (2) 1 ½" x 81 ½" Side Borders.</li> <li>○ (2) 1 ½" x 64" Top/Bottom Borders.</li> </ul> </li> </ul>
<b>B</b>	<ul style="list-style-type: none"> <li>• Cut (2) 9 ½" x 11" rectangles for the Small Pineapple Blocks.</li> </ul>
<b>C</b>	<ul style="list-style-type: none"> <li>• Cut (2) 9 ½" x 11" rectangles for the Small Pineapple Blocks.</li> </ul>
<b>D</b>	<ul style="list-style-type: none"> <li>• Cut (2) 9 ½" x 11" rectangles for the Small Pineapple Blocks.</li> </ul>
<b>E</b>	<ul style="list-style-type: none"> <li>• Cut (2) 9 ½" x 11" rectangles for the Small Pineapple Blocks.</li> </ul>
<b>F</b>	<ul style="list-style-type: none"> <li>• Cut (2) 9 ½" x 11" rectangles for the Small Pineapple Blocks.</li> </ul>
<b>G</b>	<ul style="list-style-type: none"> <li>• Cut (2) 9 ½" x 11" rectangles for the Small Pineapple Blocks.</li> </ul>
<b>H</b>	<ul style="list-style-type: none"> <li>• Cut (2) 9 ½" x 11" rectangles for the Small Pineapple Blocks.</li> </ul>
<b>I</b>	<ul style="list-style-type: none"> <li>• Cut (1) 9 ½" x 11" rectangle for the Small Pineapple Blocks.</li> </ul>
<b>J</b>	<ul style="list-style-type: none"> <li>• Cut (1) 9 ½" x 11" rectangle for the Small Pineapple Blocks.</li> </ul>
<b>K</b>	<ul style="list-style-type: none"> <li>• Cut (2) 9 ½" x 11" rectangles for the Small Pineapple Blocks.</li> </ul>
<b>L</b>	<ul style="list-style-type: none"> <li>• Cut (2) 9 ½" x 11" rectangles for the Small Pineapple Blocks.</li> </ul>
<b>M</b>	<ul style="list-style-type: none"> <li>• Cut (1) 9 ½" x 11" rectangle for the Small Pineapple Blocks.</li> </ul>



# PINEAPPLE PARADISE

<b>N</b>	<ul style="list-style-type: none"><li>• Cut (8) 2 ¼" x WOF strips for binding.</li><li>• Use remaining yardage to cut (1) 20" x 22" rectangle for the Large Pineapple Block.</li></ul>
<b>O</b>	<ul style="list-style-type: none"><li>• Cut (1) 5" x WOF strip. Subcut (2) 5" x 9 ¼" rectangles for the Large Pineapple Block.</li><li>• Cut (3) 4 ½" x WOF strips. Subcut (42) 4 ½" x 2 ½" rectangles for the Small Pineapple Blocks.</li></ul>
<b>P</b>	<ul style="list-style-type: none"><li>• Cut (1) 6 ½" x WOF strip. Subcut the following for the Large Pineapple Block:<ul style="list-style-type: none"><li>○ (1) 6 ½" square.</li><li>○ (2) 5" x 7" rectangles.</li></ul></li><li>• Cut (5) 3 ½" x WOF strips. Subcut the following for Small Pineapple Blocks:<ul style="list-style-type: none"><li>○ (21) 3 ½" squares.</li><li>○ (42) 3 ½" x 2 ½" rectangles.</li></ul></li></ul>

# PINEAPPLE PARADISE

## Large Pineapple Block Assembly:

1. Draw a diagonal line on the wrong side of (1) 6 1/2" Fabric A square.
2. Place the Fabric A square with (1) 6 1/2" Fabric P square, RST and edges aligned.
3. Sew a 1/4" away from both sides of the drawn diagonal line. Then, cut along the drawn diagonal line creating (2) HST units.
4. Trim HST units to measure 6" x 6" unfinished.

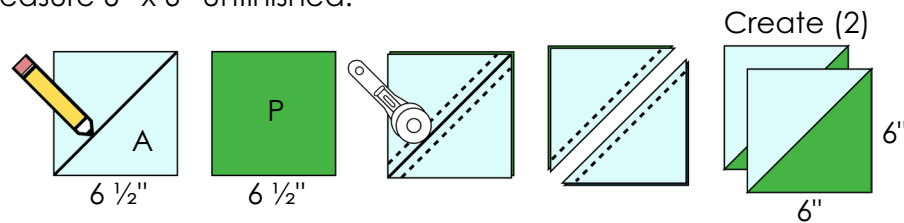

5. Draw a diagonal line on the wrong side of (2) 5" Fabric A squares. Set (1) Fabric A square aside for Step 13.
6. Place (1) Fabric A square onto the left corner of (1) 9 1/4" x 5" Fabric O rectangle as shown. Note the orientation of the drawn diagonal line.
7. Sew along the drawn diagonal line. Then, trim excess corner fabric from the bottom left corner to a 1/4". Press toward the corner to begin the left leaf unit. The left leaf unit should measure 9 1/4" x 5" unfinished at this step.

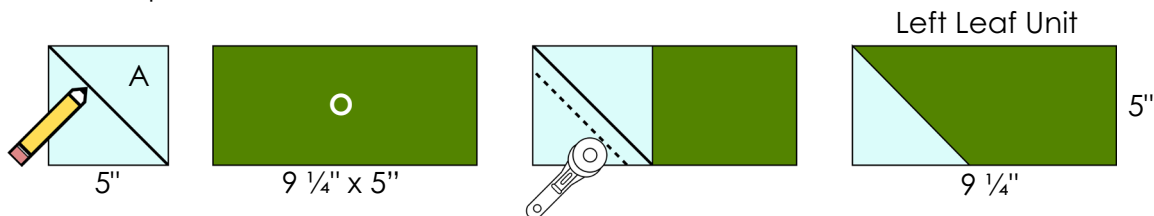

8. Place (1) 5" x 7" Fabric P rectangle onto your workstation upright as shown below.
9. Measure 5" from the top of the rectangle and mark a line across the rectangle on the wrong side. Then, mark a diagonal line from the top left corner of the rectangle to the bottom right corner where the 5" mark meets with the right raw edge of the rectangle as shown.
10. Place the marked Fabric P rectangle onto the right corner of the Fabric O rectangle, RST. Excess fabric should hang over the bottom of the Fabric O rectangle.
11. Sew along the drawn diagonal line. Then, trim excess corner fabric from the top right corner to a 1/4". Press toward the corner.
12. The Fabric P rectangle is oversized. Trim the left leaf unit to measure 10 1/4" x 5" unfinished, **trimming only from the right side.**

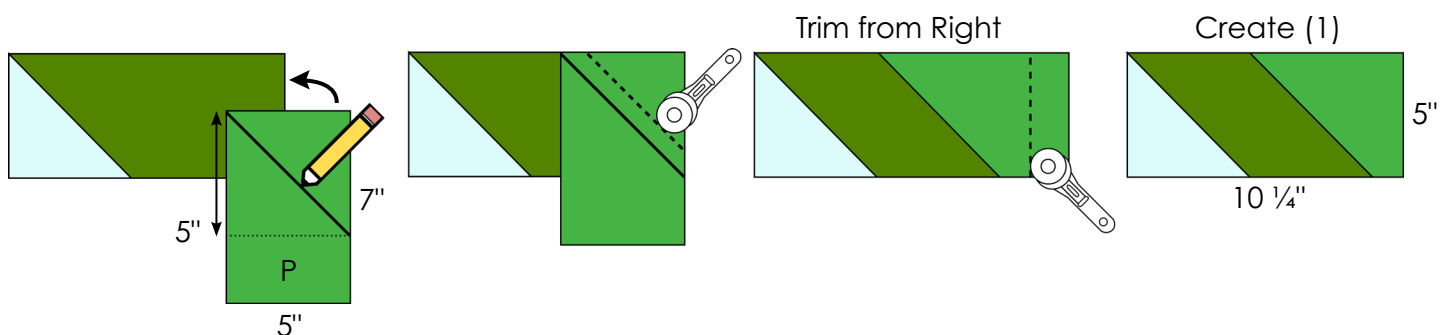

# PINEAPPLE PARADISE

13. Repeat assembly methods described in Steps 6-12 to make a **mirror image** right leaf unit. Reference the diagrams below for how to complete mirror image assembly. Trim the right leaf unit to measure 10 1/4" x 5" unfinished.

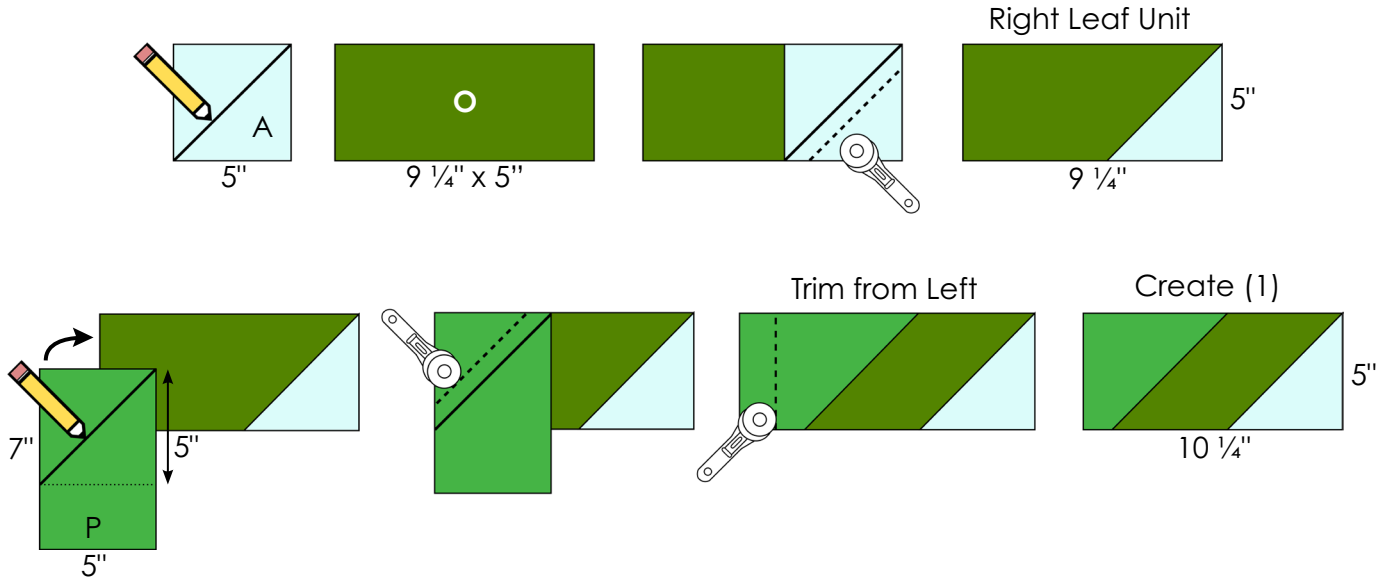

14. Draw a diagonal line on the wrong side of (4) 5" Fabric A squares.

15. Repeat SNF techniques to attach (1) Fabric A square to all corners of (1) 20" x 22" Fabric N rectangle as shown to form the pineapple unit measuring 20" x 22" unfinished.

16. Arrange the HST units, left and right leaf units, pineapple unit and (2) 4 3/4" x 6" Fabric A rectangles to form the Large Pineapple Block.

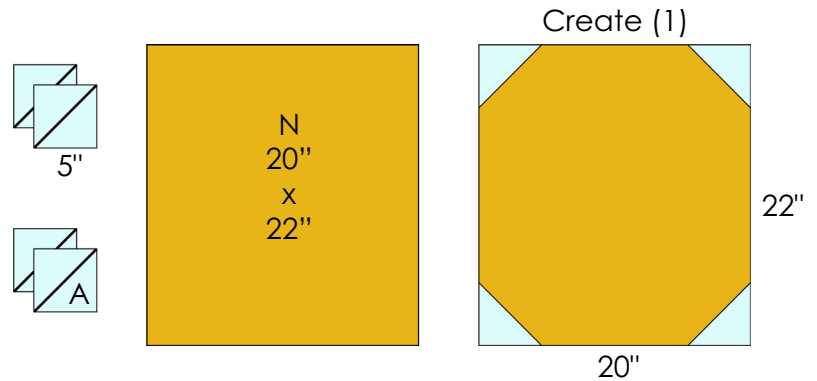

17. Sew the pieces together, using pins to align the HST units and leaf units properly. Once complete, the Large Pineapple Block should measure 20" x 32" unfinished.

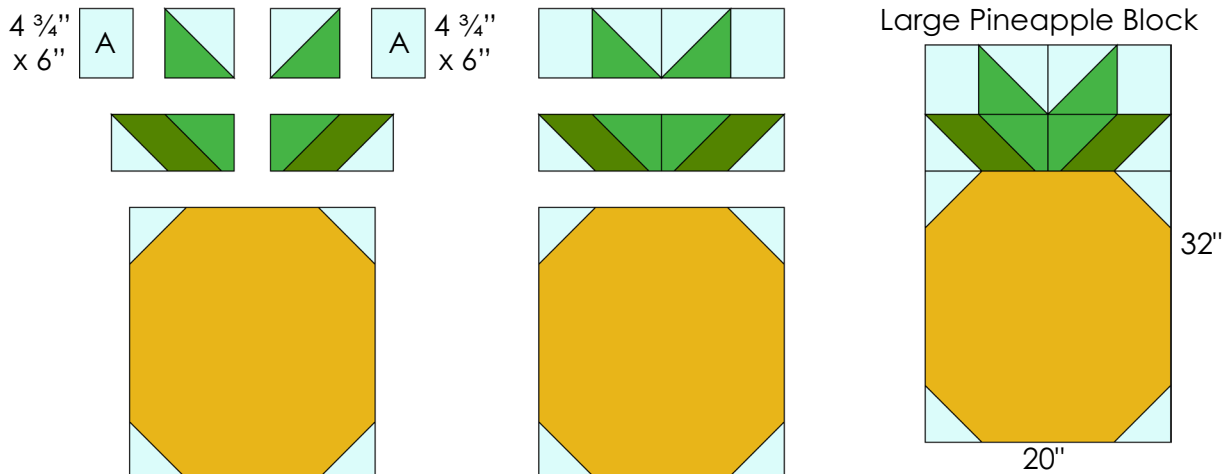

# PINEAPPLE PARADISE

## Small Pineapple Block Assembly:

18. Draw a diagonal line on the wrong side of (21) 3 1/2" Fabric A squares.
19. Repeat HST unit assembly described in Steps 2-3 to create (42) HST units using 3 1/2" squares from Fabric A and Fabric P. Trim HST units to measure 3" x 3" unfinished.

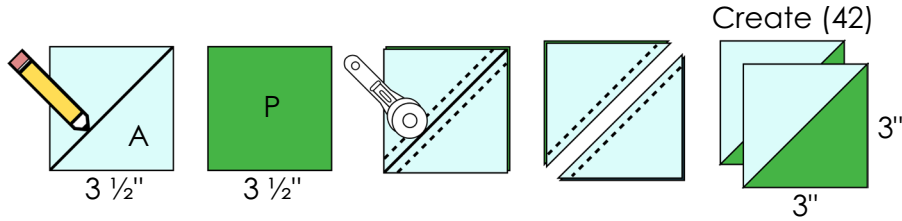

20. Repeat assembly methods for left and right leaf units described in Steps 5-13 to make (21) left leaf units and (21) right leaf units for the Small Pineapple Blocks. Although measurements for Fabric A, Fabric O and Fabric P pieces are different, assembly methods remain the same. Reference the diagram for the size of the squares and rectangles required. **Trim left and right leaf units for the Small Pineapple Blocks to measure 5" x 2 1/2" unfinished.**

Left Leaf Units - Create (21)

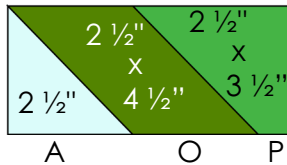

Right Leaf Units - Create (21)

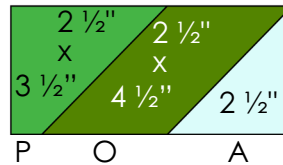

**Trim to 5" x 2 1/2" unfinished**

21. Draw a diagonal line on the wrong side of (84) 2 1/2" Fabric A squares.
22. Repeat SNF techniques to attach (1) Fabric A square to all corners of (2) 9 1/2" x 11" rectangles from each of Fabrics B, C, D, E, F, G, H, K and L and (1) 9 1/2" x 11" rectangle from each of Fabrics I, J and M. There should be (21) pineapple units measuring 9 1/2" x 11" unfinished.

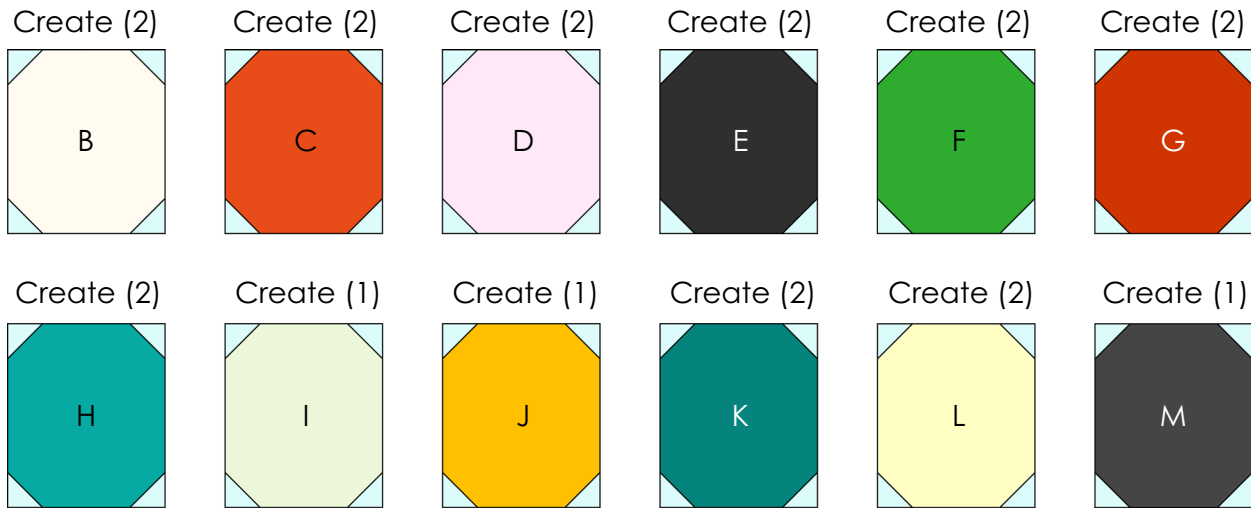

# PINEAPPLE PARADISE

23. Arrange (2) HST units, (1) of each left and right leaf unit, (1) pineapple unit and (2) 2 ½" x 3" Fabric A rectangles to form (1) Small Pineapple Block.
24. Repeat block assembly methods described in Steps 16-17 to create (1) Small Pineapple Block. Once complete, the Small Pineapple Block should measure 9 ½" x 15 ½" unfinished.
25. Repeat to create a total of (21) Small Pineapple Blocks. Reference written instructions and diagrams in Step 22 for the quantity of Small Pineapple Blocks to make with each fabric.

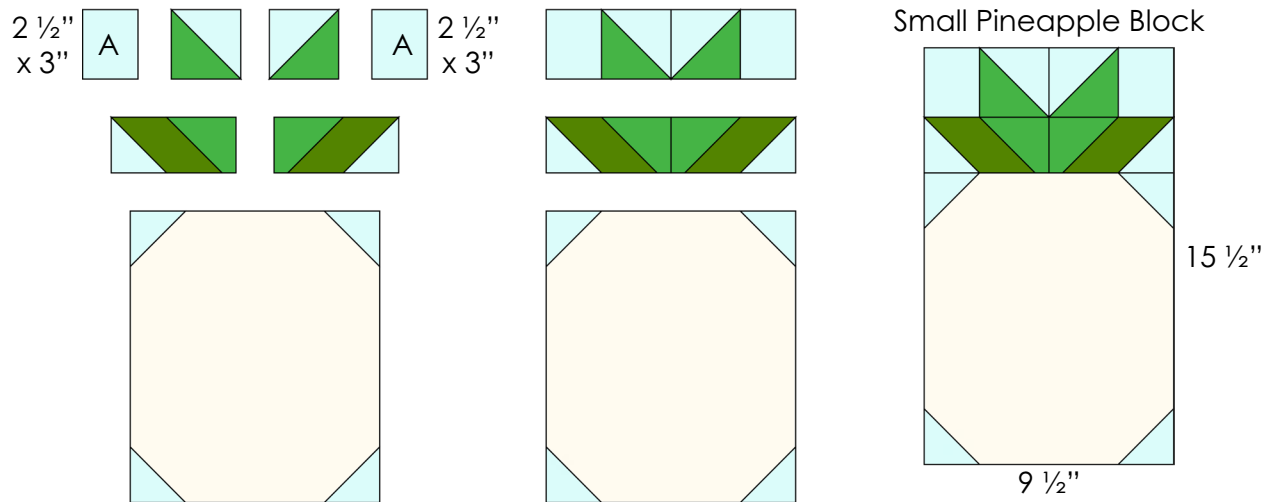

## Quilt Assembly:

26. Arrange Small Pineapple Blocks and the Large Pineapple Block as shown in the diagram on Page 8. Pineapple Blocks are labeled with a fabric label (Fabrics B-N) for their location within the quilt. Place assorted Fabric A rectangles varying in size in blank spaces around the Pineapple Blocks. Reference the diagram for the size of each Fabric A rectangle.
27. Place (1) 2" x 15 ½" Fabric A sashing rectangle vertically in between each Small Pineapple Block. Arrange sashing rows in between each Pineapple Block row using 2" Fabric A cornerstone squares and 2" x 9 ½" Fabric A sashing rectangles. Note the differences between sashing rows throughout the quilt top and around the Large Pineapple Block. *(Please note: Sashing rectangles, cornerstone squares and background are all cut from Fabric A. Fabric A cornerstone squares are used to assist in properly aligning the blocks from row to row for a neat appearance.)*
28. Sew Pineapple Block rows together, pressing seams toward the sashing rectangles and Fabric A rectangles in rows 1, 3 and 5.
29. Sew sashing rows together, pressing seams toward the sashing rectangles.
30. Sew Pineapple Block and sashing rows together, using pins to align and nestle seams. Note that the Large Pineapple Block is sewn to the right side of rows 4 and 5. Press seams toward the sashing rows. The quilt top should measure 62" x 81 ½" unfinished at this step.
31. Attach (1) 1 ½" x 81 ½" Fabric A Side Border to both sides of the quilt top. Press outward after attaching each border. Then, attach (1) 1 ½" x 64" Fabric A Top/Bottom Border to the top and bottom of the quilt top to complete assembly. The quilt top should measure 64" x 83 ½" unfinished.



# PINEAPPLE PARADISE

1 1/2" x 64"

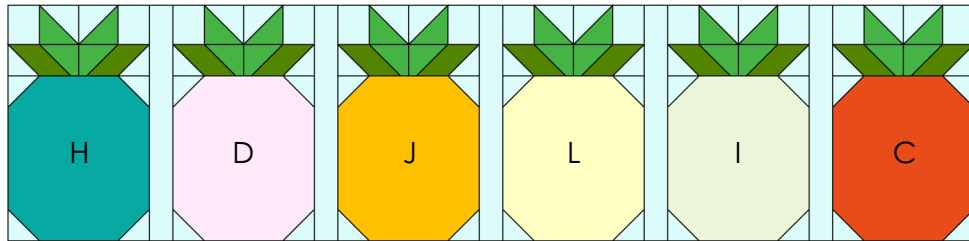
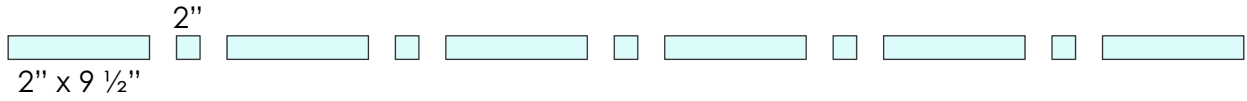
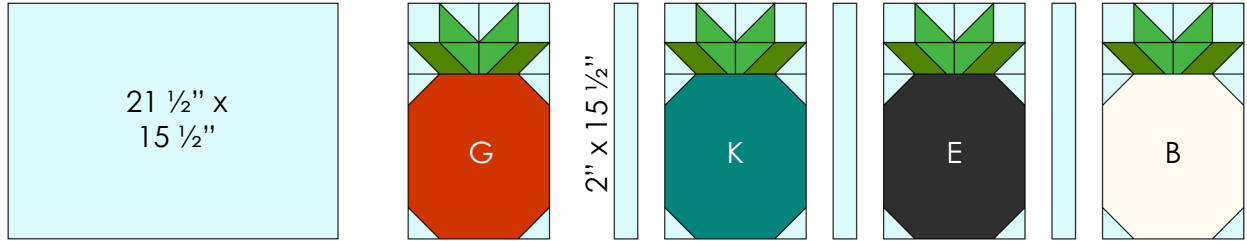

1 1/2" x 81 1/2"

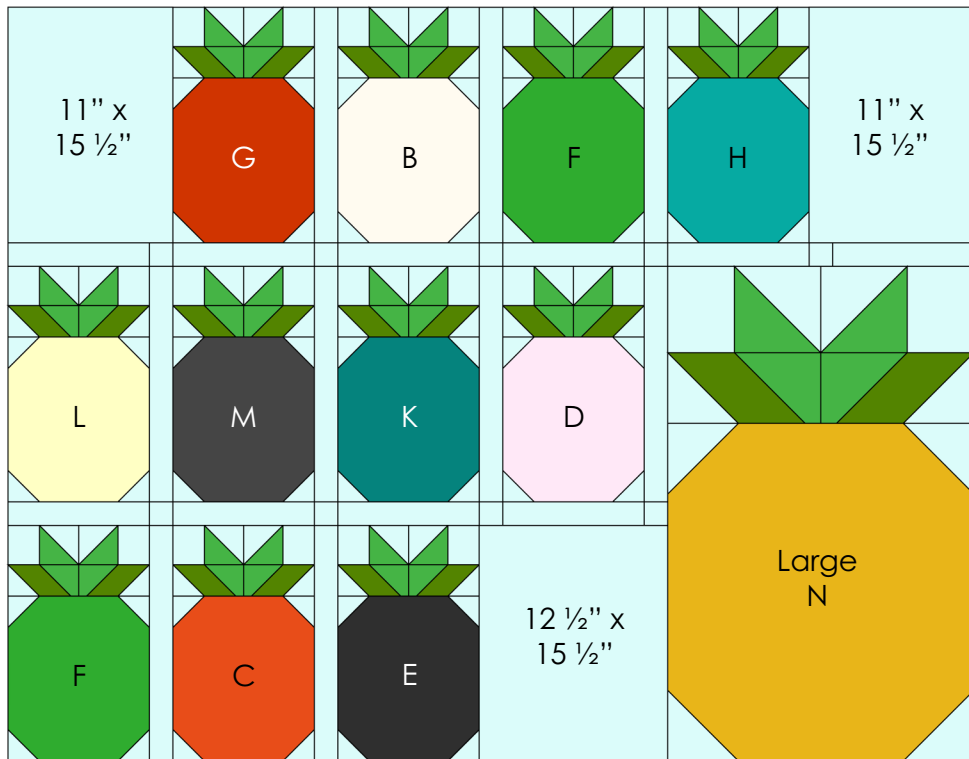

# PINEAPPLE PARADISE

## Finishing the Quilt:

32. Sandwich the quilt top with batting and backing. Baste quilt layers together using your preferred method.
33. Quilt as desired.
34. Bind quilt using (8) 2 1/4" x WOF Fabric N strips.

