

michael miller FABRICS

CHRISTMAS VILLAGE

SIZE: 70"W x 77"H • LEVEL: INTERMEDIATE • PATTERN BY: NATALIE CRABTREE • CHRISTMAS MIX FAT QUARTER BUNDLE PATTERN
AVAILABLE ON: WWW.MICHAELMILLERFABRICS.COM



THIS IS A DIGITAL REPRESENTATION OF THE QUILT TOP, FABRIC MAY VARY.

PLEASE NOTE: BEFORE BEGINNING YOUR PROJECT, CHECK FOR ANY PATTERN UPDATES AT MICHAELMILLERFABRICS.COM'S FREE PROJECTS SECTION.

p.212.704.0774 | info@michaelmillerfabrics.com | www.michaelmillerfabrics.com



CHRISTMAS VILLAGE



**CHRISTMAS MIX
FAT QUARTER BUNDLE**
containing (25) pieces
FQ0328



BACKGROUND
CX1065
Garden Pindot Snow
4 1/4 yards



BINDING & ROAD PRINT
DCX10060
Fresco Charcoal
1 yard

BACKING:
4 3/8 yards

BATTING:
77" x 85"

CUTTING INTRUCTIONS

WOF = Width of Fabric, FQ = Fat Quarter, RST = Right Sides Together, SNF = Stitch and Flip

Designer Note: There are (5) different House Blocks, labeled as A-E, featured in the Christmas Village Quilt. Each House Block features a 'main house print' and several accent prints. Cutting Instructions for the Main House Prints are provided in the chart on Page 2. Cutting Instructions for accent prints are provided at the start of each House Block Assembly Section on Pages 4-9. Customize each House Block with unique color combinations!

Cutting Instructions for Tree Blocks are listed below and on Page 2. It is recommended to cut green prints for Tree Blocks before House Block Assembly begins to avoid green print fabric shortages.

It is recommended to separate the cut pieces by the block type specified for organization.

KEY	CUTTING INTRUCTIONS
<p>From the FQ Bundle</p>	<ul style="list-style-type: none"> • Gather the green prints from the FQ Bundle. To make (1) Tree Block, cut the following from (1) green print. Clip or pin pieces together for organization. Repeat Cutting Instructions below (11) times for (11) Tree Blocks. <ul style="list-style-type: none"> ○ From (1) green print: <ul style="list-style-type: none"> • (1) 2 1/2" x 8 1/2" rectangle. • (1) 2 1/2" x 7 1/2" rectangle. • (1) 2 1/2" x 6 1/2" rectangle. • (1) 2 1/2" x 5 1/2" rectangle. • (1) 2 1/2" x 4 1/2" rectangle. <p style="text-align: right;"><i>(FQ Bundle cutting continued on the next page)</i></p>

CHRISTMAS VILLAGE

<p>From the FQ Bundle cont.</p>	<ul style="list-style-type: none"> • Gather the dark grey and black prints from the FQ Bundle. Proceed using the following Cutting Instructions: <ul style="list-style-type: none"> ○ To make (1) House Block, cut the following from (1) dark grey or black print. Clip or pin pieces together for organization. Repeat Cutting Instructions below (19) times for (19) House Blocks. <ul style="list-style-type: none"> • From (1) dark grey or black print: <ul style="list-style-type: none"> ○ (2) 1 ½" x 2 ½" rectangles (<i>chimney rectangles</i>). ○ From assorted dark grey and black prints, cut a total of (11) 1 ½" x 2 ½" rectangles for Tree Blocks. • Gather all medium-dark prints from the FQ Bundle. To make (1) House Block, cut the following from (1) medium-dark print for the 'main house print'. Clip or pin pieces together for organization. Repeat Cutting Instructions below (19) times for (19) House Blocks. (<i>Designer Note: Use pieces on House Blocks A-E.</i>) <ul style="list-style-type: none"> ○ (1) Roof Template B. ○ (1) Roof Template D. ○ (4) 1 ½" x 3 ½" rectangles. ○ (2) 1" x 5 ½" rectangles. ○ (2) 1" x 4 ½" rectangles.
<p>From the Background</p>	<ul style="list-style-type: none"> • Cut (5) 2 ½" x WOF strips. Subcut the following for House Blocks: <ul style="list-style-type: none"> ○ (19) 2 ½" x 4 ½" rectangles. ○ (38) 2 ½" x 2" rectangles. • Cut (4) 2 ½" x WOF strips. Unfold WOF strips before cutting so that there is only (1) layer of fabric. Subcut the following for House Blocks: <ul style="list-style-type: none"> ○ (19) Roof Template A. Turn the template 180° after each cut to best utilize fabrics. ○ (19) Roof Template C. ○ (19) Roof Template E. Turn the template 180° after each cut to best utilize fabrics. • Cut (5) 1 ½" x WOF strips. Subcut the following for House Blocks: <ul style="list-style-type: none"> ○ (19) 1 ½" x 5 ½" rectangles. ○ (19) 1 ½" x 3 ½" rectangles. • Cut (17) 2 ½" x WOF strips. Subcut the following for Tree Blocks: <ul style="list-style-type: none"> ○ (22) 2 ½" x 4 ½" rectangles. ○ (22) 2 ½" x 3" rectangles. ○ (132) 2 ½" squares. ○ (22) 2 ½" x 2" rectangles. ○ (22) 2 ½" x 1 ½" rectangles. ○ (22) 2 ½" x 1" rectangles. • Cut (9) 2 ½" x WOF strips. Subcut (25) 2 ½" x 12 ½" sashing rectangles for Quilt Assembly. • Cut (5) 3 ½" x WOF strips. Subcut (19) 3 ½" x 9 ½" filler rectangles for Quilt Assembly. <p style="text-align: right;"><i>(Background cutting continued on the next page)</i></p>

CHRISTMAS VILLAGE

<p>From the Background cont.</p>	<ul style="list-style-type: none"> • Cut (11) 1 1/2" x WOF strips. Piece strips for length using diagonal seams. From the long strip, subcut the following for Quilt Assembly: <ul style="list-style-type: none"> ○ (4) 1 1/2" x 64 1/2" sashing strips. ○ (2) 1 1/2" x 69 1/2" Side Inner Borders. • Cut (4) 2 1/2" x WOF strips. Piece (2) strips for length using a diagonal seam. Repeat to make (2) long strips. Trim each strip to measure 2 1/2" x 66 1/2" for Top/Bottom Inner Borders. • Cut (4) 2 1/2" x WOF strips. Leave WOF strips whole for Border Assembly.
<p>From the Binding & Road Print</p>	<ul style="list-style-type: none"> • Cut (8) 2 1/4" x WOF strips for binding. • Cut (9) 1 1/2" x WOF strips. Piece strips for length using diagonal seams. From the long strip, subcut (5) 1 1/2" x 64 1/2" road strips. Set aside for Quilt Assembly.

Basic House Block Assembly:

Designer Note: Steps 1-3 provide basic assembly instructions for House Blocks. Use the general instructions in Steps 1-3 and diagrams when creating House Blocks A-E. Basic House Block Assembly is transferrable between house block types. House Blocks A-E feature a different 'unit' as described in the bottom bullet.

1. Gather the following pieces to create (1) House Block. The following pieces are required for all House Block types (A-E). Reference the following list, instructions and diagrams to create House Blocks A-E.

- From (1) main house print:
 - (1) Roof Template B.
 - (1) Roof Template D.
 - (4) 1 1/2" x 3 1/2" rectangles.
 - (2) 1" x 5 1/2" rectangles.
 - (2) 1" x 4 1/2" rectangles.
- From background:
 - (1) Roof Template A.
 - (1) Roof Template C.
 - (1) Roof Template E.
 - (1) 4 1/2" x 2 1/2" rectangle.
 - (2) 2" x 2 1/2" rectangles.
 - (1) 1 1/2" x 5 1/2" rectangle.
 - (1) 1 1/2" x 3 1/2" rectangle.
- From (1) dark grey or black print:
 - (2) 1 1/2" x 2 1/2" chimney rectangles.
- (1) unit, unique to House Blocks A-E. Units all measure 4 1/2" x 4 1/2" unfinished.

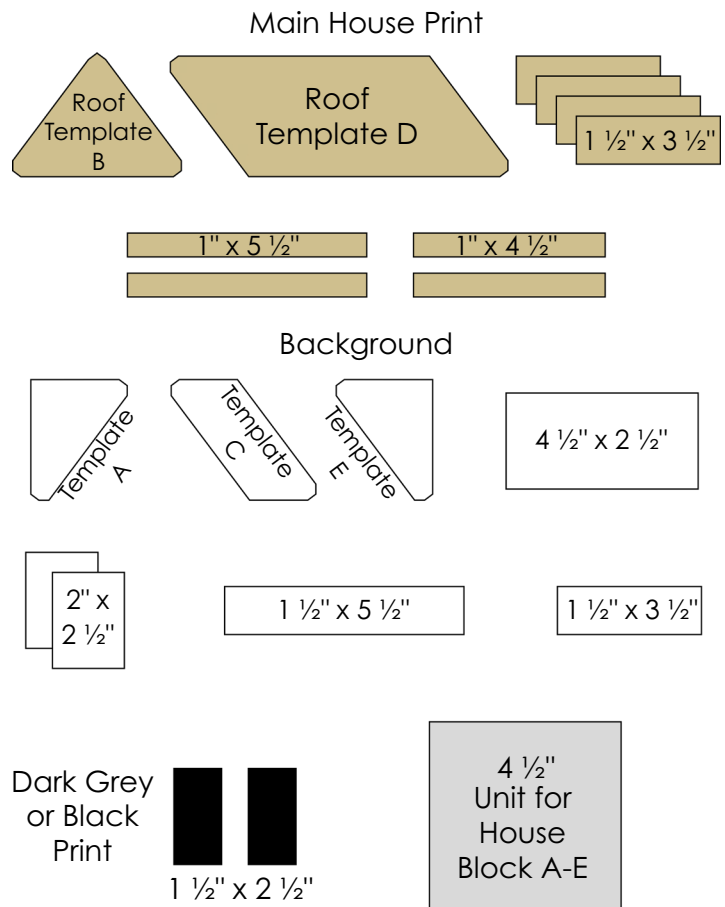

CHRISTMAS VILLAGE

- Arrange the pieces gathered in Step 1 to form (1) House Block.
- Sew the House Block together. Use the blunted edges of the templates to properly align the templates for sewing. Arrows indicate pressing instructions. The completed House Block should measure $9\frac{1}{2}'' \times 9\frac{1}{2}''$ unfinished.

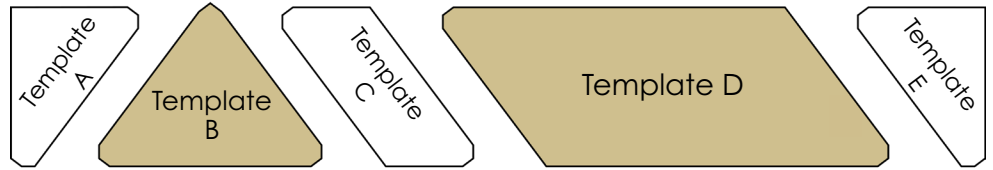
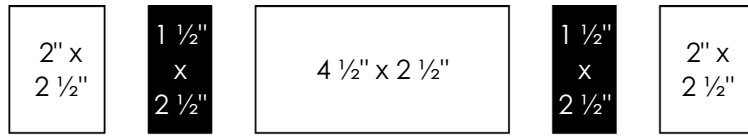

USE GENERAL ASSEMBLY FOR HOUSE BLOCKS A-E

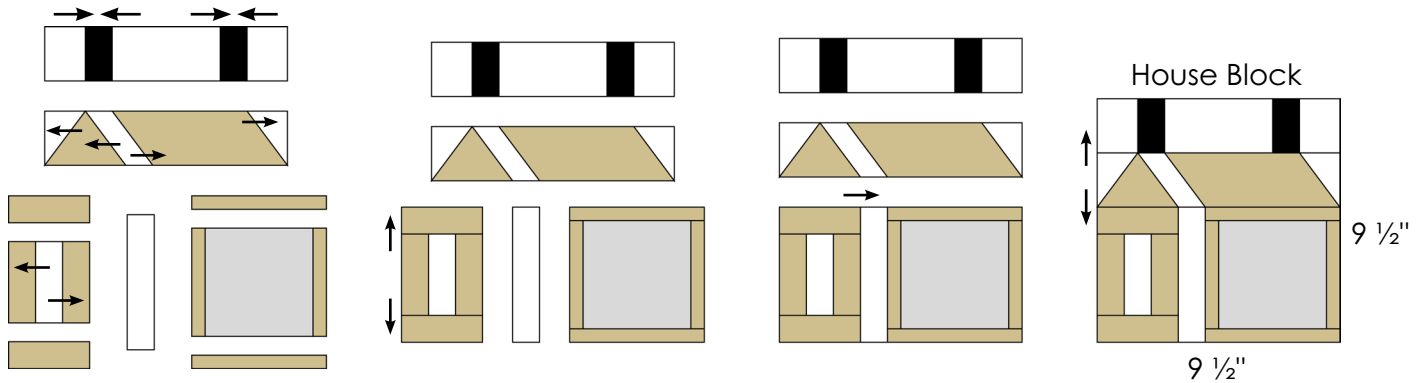
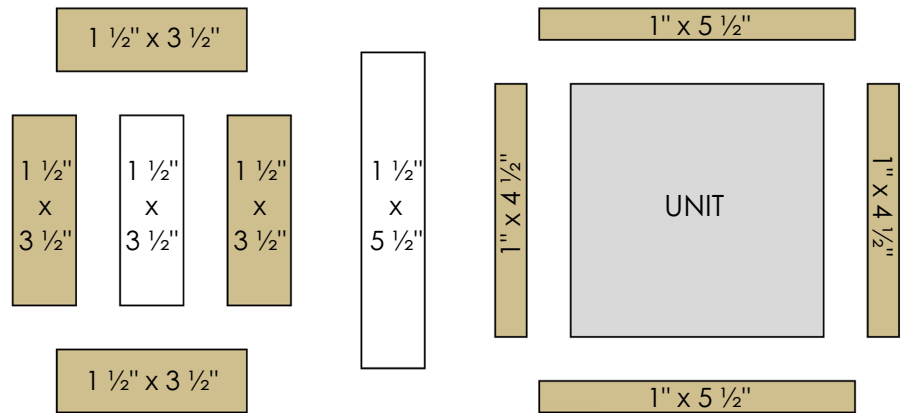

House Block A Assembly:

- Cut the following pieces from the FQ Bundle to make (1) unit for House Block A. Each House Block A unit will contain a unique combination of prints.
 - From (1) print. **Label as Print A.**
 - (1) $2\frac{1}{2}''$ square.
 - (8) $1\frac{1}{2}''$ squares.
 - From (1) print. **Label as Print B.**
 - (4) $1\frac{1}{2}'' \times 2\frac{1}{2}''$ rectangles.
 - (4) $1\frac{1}{2}''$ squares.

House Block A

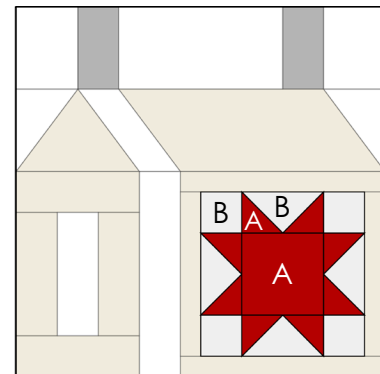

CHRISTMAS VILLAGE

5. Draw a diagonal line on the wrong side of (8) 1 1/2" Print A squares.
6. Place (1) 1 1/2" Print A square onto the corner of (4) 2 1/2" x 1 1/2" Print B rectangles, RST and edges aligned. Note the orientation of the drawn diagonal line in the diagram.
7. Sew along the drawn diagonal lines. Then, trim excess corner fabric to a 1/4". Press toward the corners.
8. Repeat SNF techniques to attach (1) 1 1/2" Print A square to the adjacent corner of each Print B rectangle to complete (4) flying geese units. The flying geese units should measure 2 1/2" x 1 1/2" unfinished.

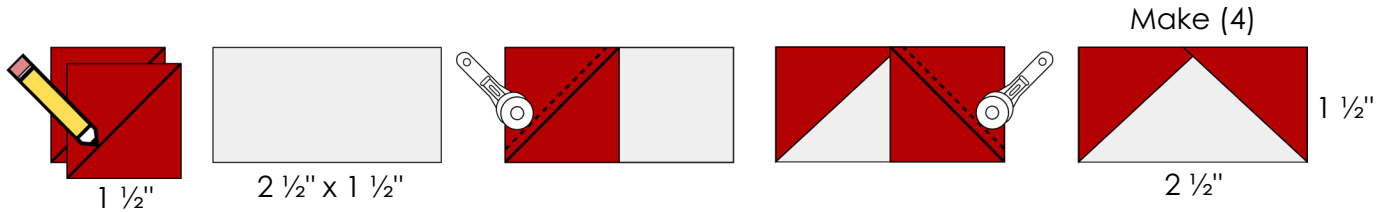

9. Arrange (4) flying geese units and the remaining pieces cut during Step 1 to form (1) House Block A unit.
10. Sew together, pressing seams toward squares. The House Block A unit should measure 4 1/2" x 4 1/2" unfinished.

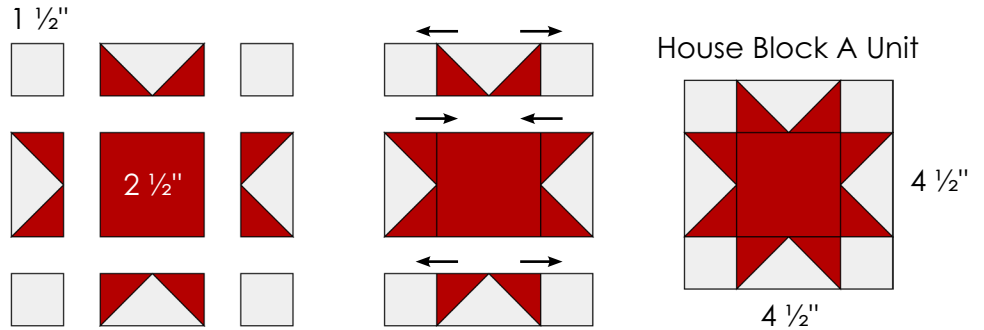

11. Pair the House Block A unit with (1) set of main house print pieces and (2) chimney rectangles cut during the Cutting Instructions and assorted background pieces. Reference Step 1 for the required pieces.
12. Sew House Block A together, referencing written instructions and diagrams in Steps 1-3. The completed House Block A should measure 9 1/2" x 9 1/2" unfinished.
13. Repeat to create a total of (4) House Block A as described in Steps 4-12.

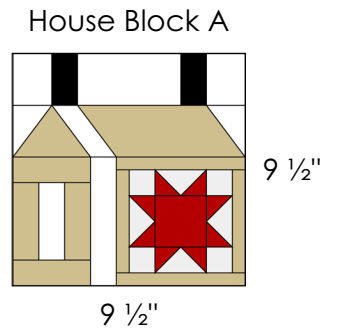

Make (4) House Block A

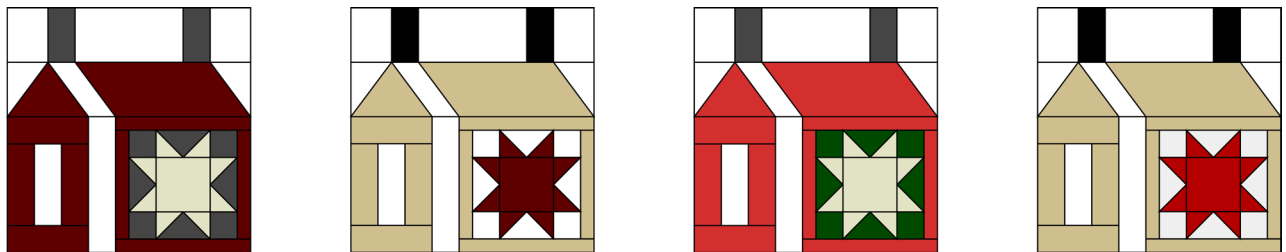

CHRISTMAS VILLAGE

House Block B Assembly:

14. Cut the following pieces from the FQ Bundle to make (1) unit for House Block B. Each House Block B unit will contain a unique combination of prints.

- From (1) print. **Label as Print A.**
 - (1) 1 ½" square.
 - (2) 1" x 2 ½" rectangles.
 - (2) 1" x 3 ½" rectangles.
- From (1) print. **Label as Print B.**
 - (2) 1" x 1 ½" rectangles.
 - (2) 1" x 2 ½" rectangles.
 - (2) 1" x 3 ½" rectangles.
 - (2) 1" x 4 ½" rectangles.

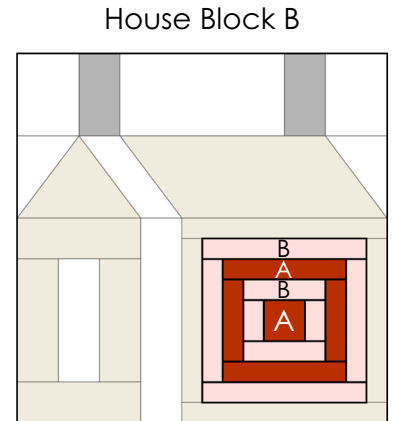

15. Arrange the pieces gathered in Step 14 as shown in the diagram.

16. Sew together by adding layers onto the center 1 ½" Print A square. Press outward after attaching each rectangle. The House Block B unit should measure 4 ½" x 4 ½" unfinished.

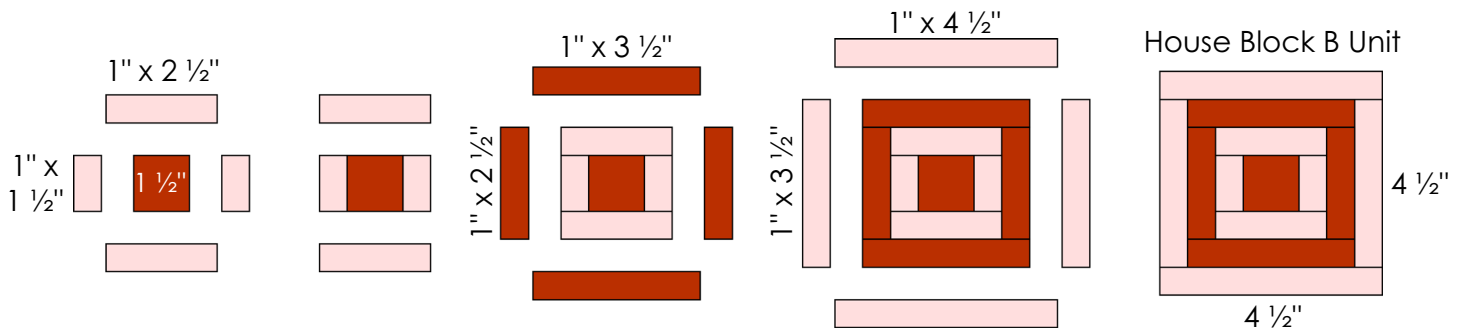

17. Pair the House Block B unit with (1) set of main house print pieces and (2) chimney rectangles cut during the Cutting Instructions and assorted background pieces. Reference Step 1 for the required pieces.

18. Sew House Block B together, referencing written instructions and diagrams in Steps 1-3. The completed House Block B should measure 9 ½" x 9 ½" unfinished.

19. Repeat to create a total of (3) House Block B as described in Steps 14-18.

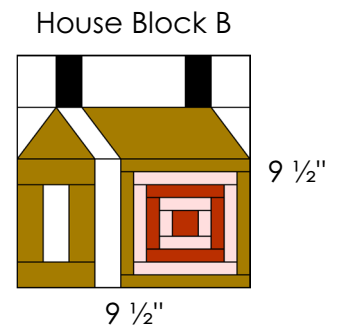

Make (3) House Block B

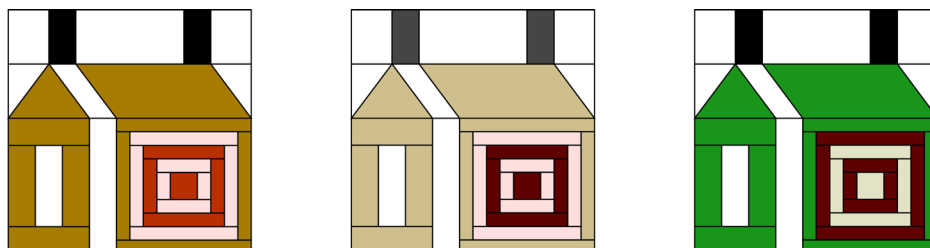

CHRISTMAS VILLAGE

House Block C Assembly:

20. Cut the following pieces from the FQ Bundle to make (1) unit for House Block C. Each House Block C unit will contain a unique combination of prints.

- From (1) light print. **Label as Print A.**
 - (1) 1 ½" x 2 ½" rectangle.
 - (2) 1 ½" squares.
 - (2) 1" x 3 ½" rectangles.
- From (1) print. **Label as Print B.**
 - (4) 1 ¾" squares.
- From (1) print. **Label as Print C.**
 - (2) 1 ½" squares.
 - (1) 1" x 3 ½" rectangle.
 - (2) 1" x 1 ¾" rectangles.

House Block C

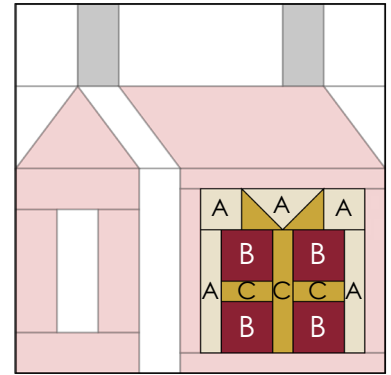

21. Draw a diagonal line on the wrong side of (2) 1 ½" Print C squares.

22. Repeat SNF techniques to create (1) flying geese unit using (2) 1 ½" Print C squares and (1) 2 ½" x 1 ½" Print A rectangle. The flying geese unit should measure 2 ½" x 1 ½" unfinished.

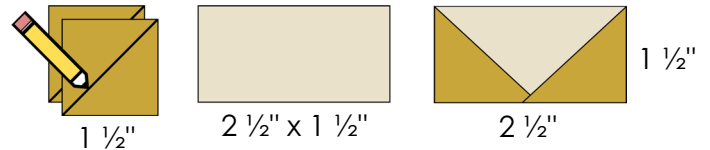

23. Arrange (1) flying geese unit and the remaining pieces cut during Step 20 to form (1) House Block C unit.

24. Sew together, pressing seams toward Prints A and C. The House Block C unit should measure 4 ½" x 4 ½" unfinished.

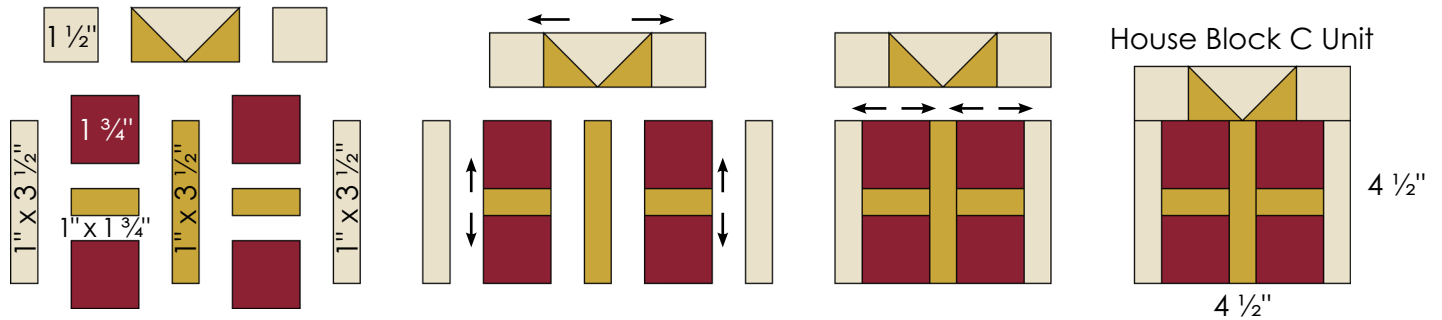

25. Pair the House Block C unit with (1) set of main house print pieces and (2) chimney rectangles cut during the Cutting Instructions and assorted background pieces. Reference Step 1 for the required pieces.

26. Sew House Block C together, referencing written instructions and diagrams in Steps 1-3. The completed House Block C should measure 9 ½" x 9 ½" unfinished.

27. Repeat to create a total of (3) House Block C as described in Steps 20-26.

House Block C

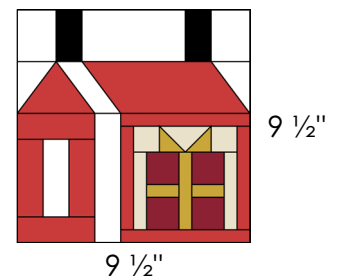

CHRISTMAS VILLAGE

Make (3) House Block C

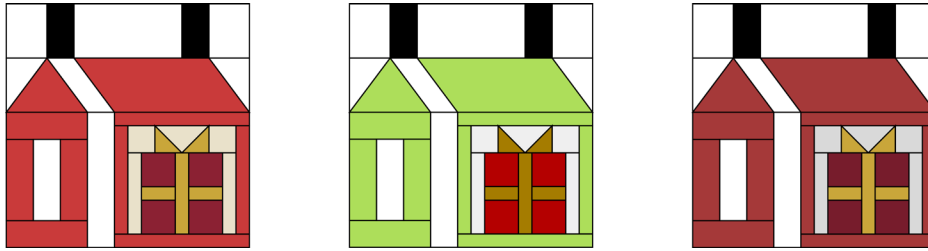

House Block D Assembly:

28. Cut the following pieces from the FQ Bundle to make (1) unit for House Block D. Each House Block D unit will contain a unique combination of prints.

- From (1) print. **Label as Print A.**
 - (1) 4 ½" square.
- From (1) print. **Label as Print B.**
 - (4) 2 ½" squares.

29. Draw a diagonal line on the wrong side of (4) 2 ½" Print B squares.

30. Repeat SNF techniques to create (1) square-in-a-square unit using (4) 2 ½" Print B squares and (1) 4 ½" Print A square. Attach (1) Print B square to (2) opposite corners of the Print A square first. Then attach (1) Print B square to the remaining Print A square corners. The square-in-a-square unit should measure 4 ½" x 4 ½" unfinished.

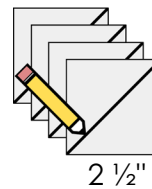

House Block D Unit

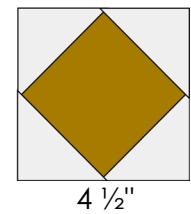

4 ½"

4 ½"

31. Pair the House Block D unit with (1) set of main house print pieces and (2) chimney rectangles cut during the Cutting Instructions and assorted background pieces. Reference Step 1 for the required pieces.

32. Sew House Block D together, referencing written instructions and diagrams in Steps 1-3. The completed House Block D should measure 9 ½" x 9 ½" unfinished.

33. Repeat to create a total of (5) House Block D as described in Steps 28-32.

House Block D

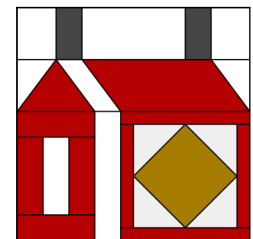

9 ½"

9 ½"

Make (5) House Block D

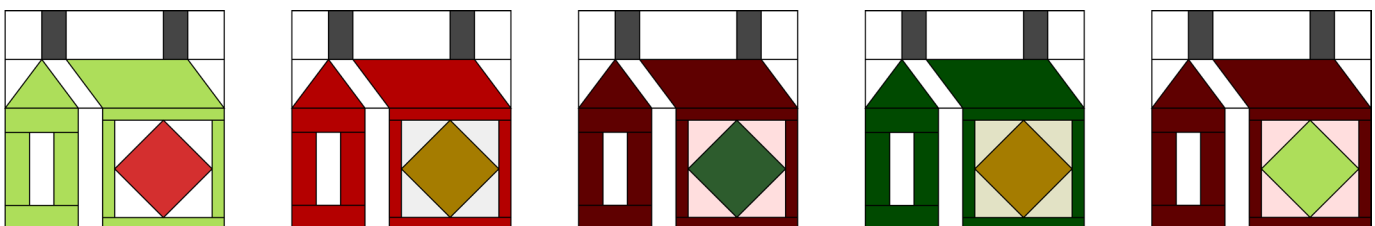

CHRISTMAS VILLAGE

House Block E Assembly:

34. Cut the following pieces from the FQ Bundle to make (1) unit for House Block E. Each House Block E unit will contain a unique combination of prints.

- From (1) print. **Label as Print A.**
 - (1) Tree Template A.
- From (1) light print. **Label as Print B.**
 - (1) Tree Template B.
 - (1) Tree Template C.
 - (2) 2 ¼" x 1 ½" rectangles.
- From (1) print. **Label as Print C.**
 - (1) 1" x 1 ½" rectangle.

House Block E

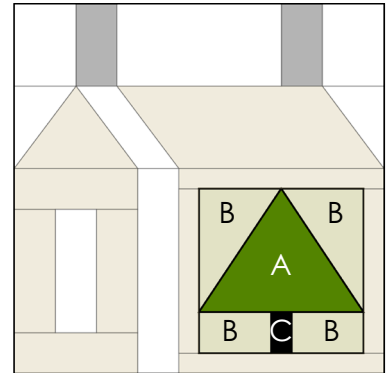

35. Arrange the pieces gathered in Step 34 as shown in the diagram.

36. Sew together, referencing the diagrams. Use the blunted edges of the templates to properly align the templates for sewing. Press toward Print B. The House Block E unit should measure 4 ½" x 4 ½" unfinished.

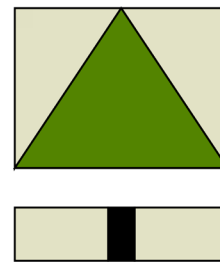
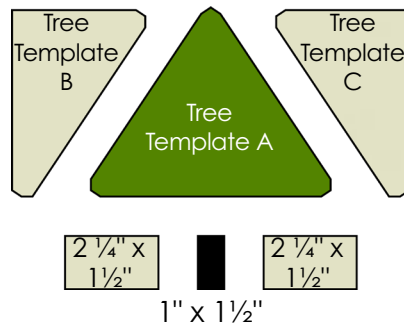

House Block E Unit

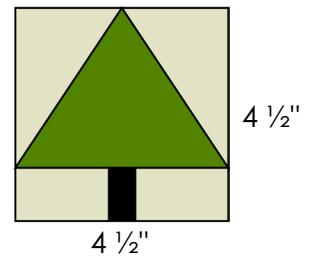

37. Pair the House Block E unit with (1) set of main house print pieces and (2) chimney rectangles cut during the Cutting Instructions and assorted background pieces. Reference Step 1 for the required pieces.

38. Sew House Block E together, referencing written instructions and diagrams in Steps 1-3. The completed House Block E should measure 9 ½" x 9 ½" unfinished.

39. Repeat to create a total of (4) House Block E as described in Steps 34-38.

House Block E

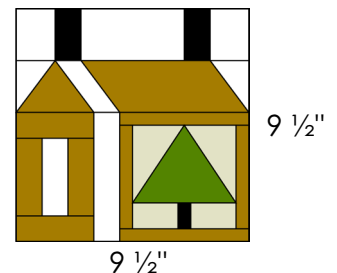

Make (4) House Block E

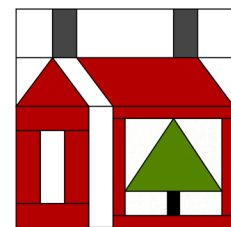
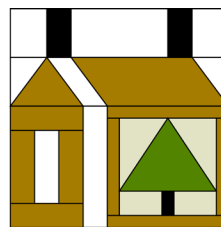
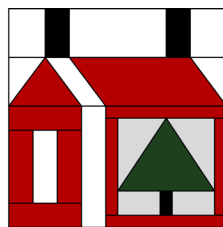
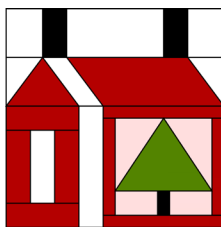

CHRISTMAS VILLAGE

Tree Block Assembly:

40. Gather the following print pieces to make (1) Tree Block:

- From (1) green print:
 - (1) 8 1/2" x 2 1/2" rectangle.
 - (1) 7 1/2" x 2 1/2" rectangle.
 - (1) 6 1/2" x 2 1/2" rectangle.
 - (1) 5 1/2" x 2 1/2" rectangle.
 - (1) 4 1/2" x 2 1/2" rectangle.
- From (1) dark grey or black print:
 - (1) 1 1/2" x 2 1/2" rectangle.

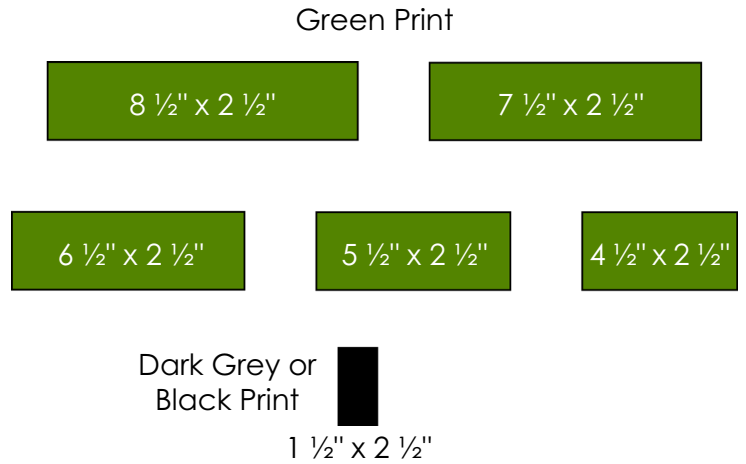

41. Draw a diagonal line on the wrong side of (10) 2 1/2" background squares.

42. Repeat SNF techniques to attach (1) 2 1/2" background square to both top corners of each green print rectangle. Reference the diagrams for the unfinished measurement of each SNF unit.

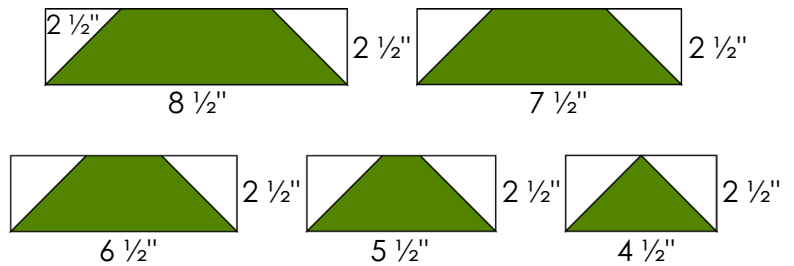

43. Arrange the SNF units with (1) 1 1/2" x 2 1/2" dark grey or black print rectangle gathered in Step 40 with assorted background pieces. Reference the labeled diagram for the location and size of each background piece.

44. Sew the Tree Block together, pressing seams away from the SNF units. The Tree Block should measure 9 1/2" x 12 1/2" unfinished.

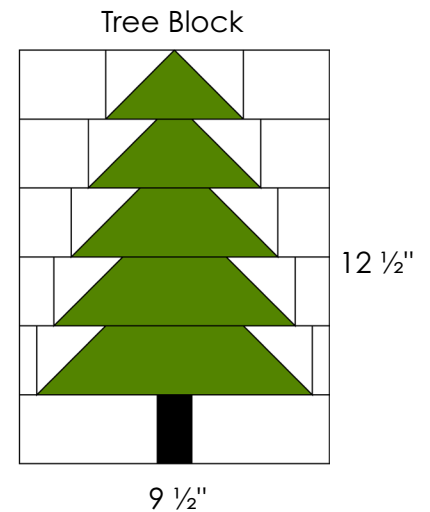
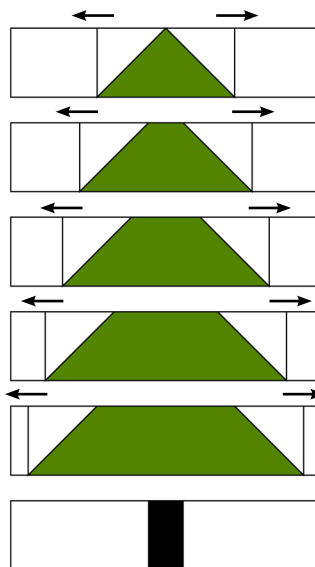
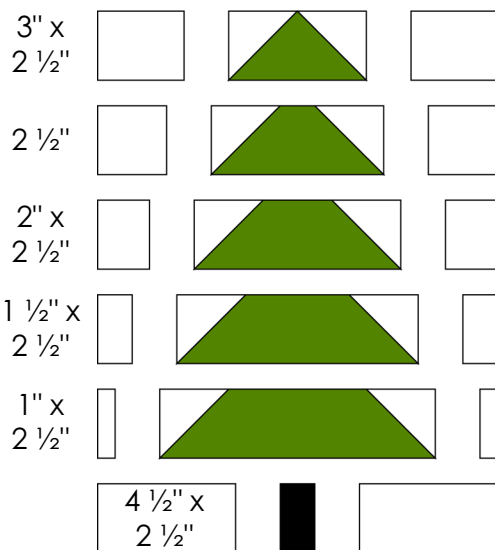

CHRISTMAS VILLAGE

45. Repeat to create (11) Tree Blocks, each using only (1) green print.

Make (11) Tree Blocks

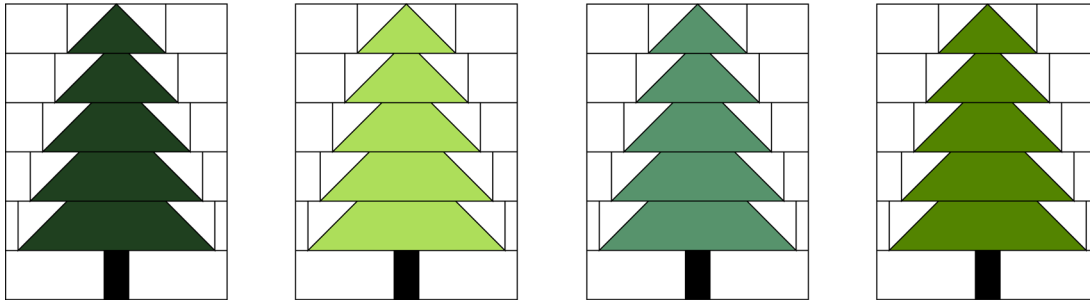

Border Assembly:

46. Using the remaining FQ and scraps from the FQ Bundle, cut the following for Outer Borders:

- (84) 2 ½" assorted squares.

47. Sew random squares together end to end in the following quantity for Outer Borders. Label for Left Side, Right Side, Top or Bottom Outer Borders as indicated. Then, sew (1) 2 ½" x WOF background strip to the end of each long row of squares.

- **Left Side:** Sew (21) 2 ½" squares together + (1) 2 ½" x WOF background strip.
- **Right Side:** Sew (18) 2 ½" squares together + (1) 2 ½" x WOF background strip.
- **Top:** Sew (22) 2 ½" squares together + (1) 2 ½" x WOF background strip.
- **Bottom:** Sew (23) 2 ½" squares together + (1) 2 ½" x WOF background strip.

Left Side: (21) 2 ½" squares



Right Side: (18) 2 ½" squares



Top: (22) 2 ½" squares



Bottom: (23) 2 ½" squares



Final Quilt Assembly:

48. Arrange House Blocks A-E and Tree Blocks into (5) horizontal block rows. Place (1) 9 ½" x 3 ½" background filler rectangle above each House Block, and use 2 ½" x 12 ½" background sashing rectangles between **most** blocks. Reference the diagram on Page 12 for placement of background sashing rectangles. Placement varies.

CHRISTMAS VILLAGE

49. Sew horizontal block rows together, pressing seams toward the background rectangles. Horizontal block rows should measure $64 \frac{1}{2}$ " x $12 \frac{1}{2}$ " unfinished.
50. Sew (1) $1 \frac{1}{2}$ " x $64 \frac{1}{2}$ " road strip to the bottom of horizontal block rows 1-5. Press toward the road strips. Then, sew (1) $1 \frac{1}{2}$ " x $64 \frac{1}{2}$ " background sashing strip to the bottom of horizontal block rows 1-4. **Do not sew a background sashing strip to the bottom of horizontal block row 5.**
51. Next, sew all horizontal block rows together, pressing seams toward the background sashing strips. The quilt top should measure $64 \frac{1}{2}$ " x $69 \frac{1}{2}$ " unfinished.

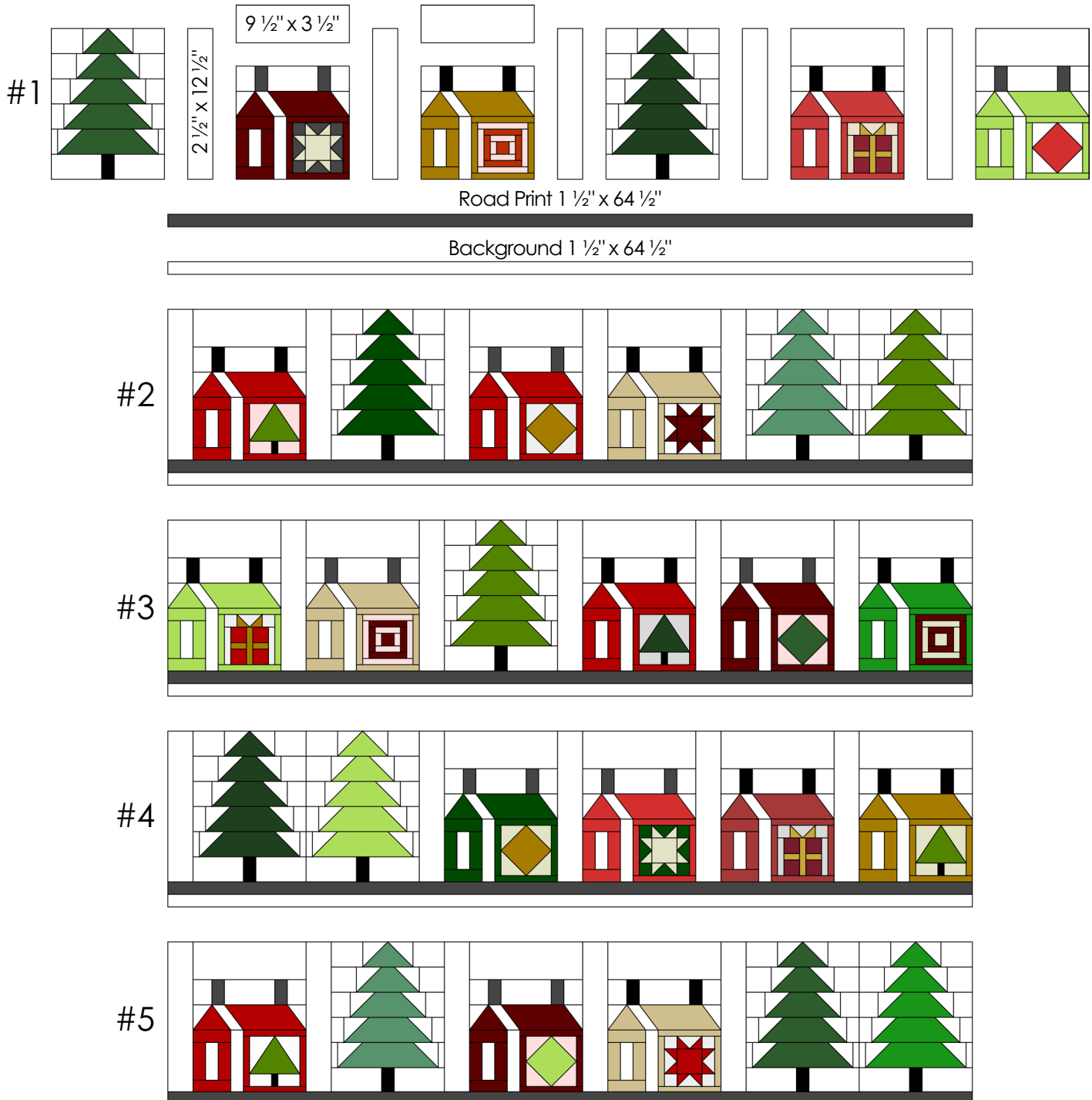

CHRISTMAS VILLAGE

52. Sew (1) 1 ½" x 69 ½" background Side Inner Border to both sides of the quilt top. Press outward after attaching each border. Then, sew (1) 2 ½" x 66 ½" background Top/Bottom Inner Border to the top and bottom of the quilt top. The quilt top should measure 66 ½" x 73 ½" unfinished at this step.
53. Align the Left Side Outer Border strip created on Page 11 with the left side of the quilt top, ensuring that the top left corner of the quilt top aligns with the 2 ½" square end of the Left Side Outer Border strip. Pin in place starting with the 2 ½" square end. Continue pinning thoroughly along the entire length of the border strip. Then, trim excess fabric from the 2 ½" x WOF background strip so that the border strip and the left side of the quilt are the same size.
54. Sew the Left Side Outer Border strip to the quilt top, and press outward.
55. Repeat trimming and sewing methods described in Steps 53-54 to attach the Right Side Outer Border strip created on Page 11. Then, attach the Top & Bottom Outer Border strips. Note that 2 ½" squares meet in the top left and bottom right corners of the quilt top. The quilt top should measure approximately 70 ½" x 77 ½" unfinished.



CHRISTMAS VILLAGE

Finishing the Quilt:

56. Sandwich the quilt top with batting and backing. Baste quilt layers together using your preferred method.
57. Quilt as desired.
58. Bind quilt using (8) 2 1/4" x WOF strips.





CHRISTMAS VILLAGE TEMPLATES

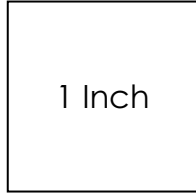

Print at 100% or
Actual Size

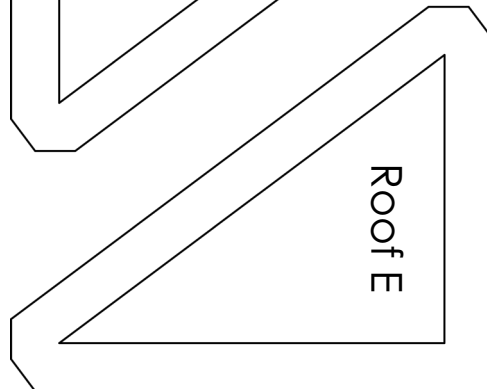
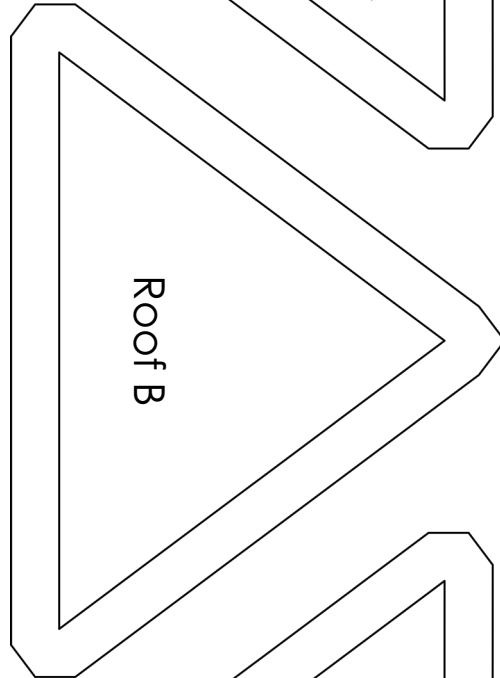
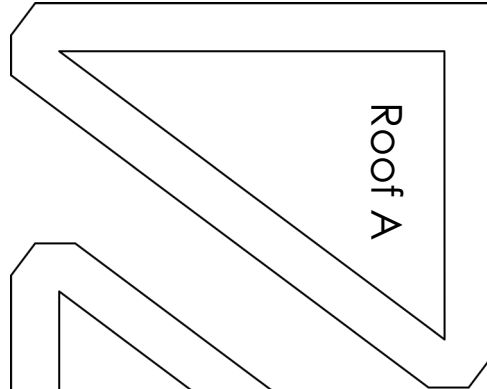
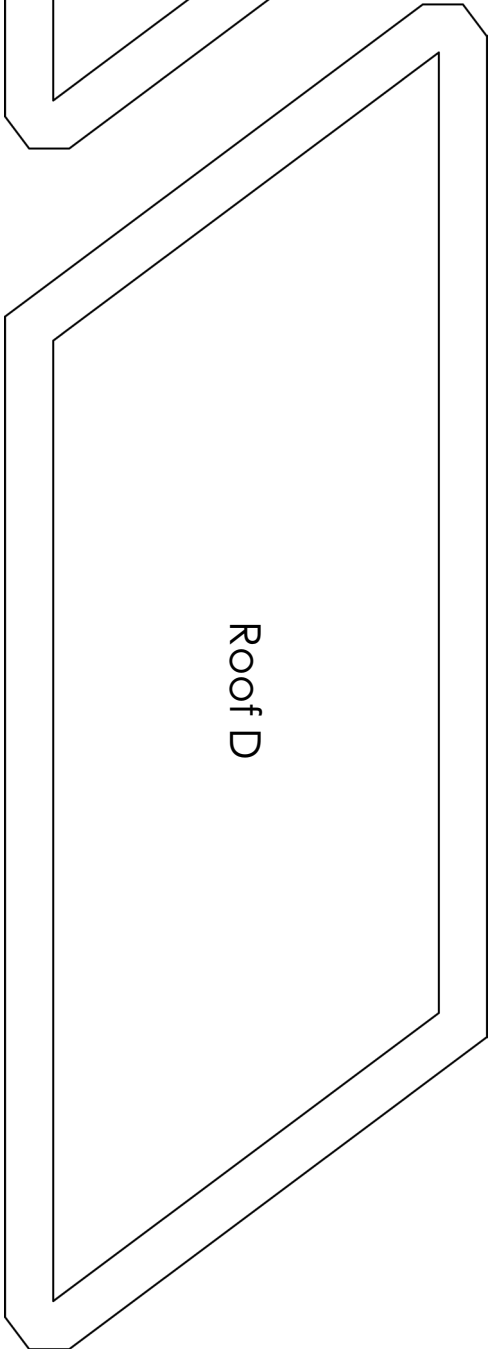
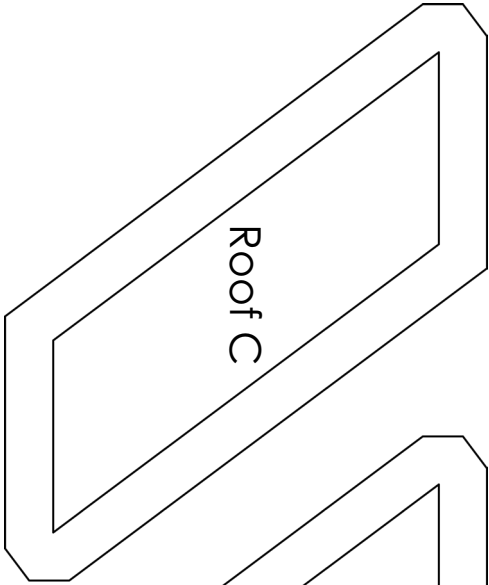
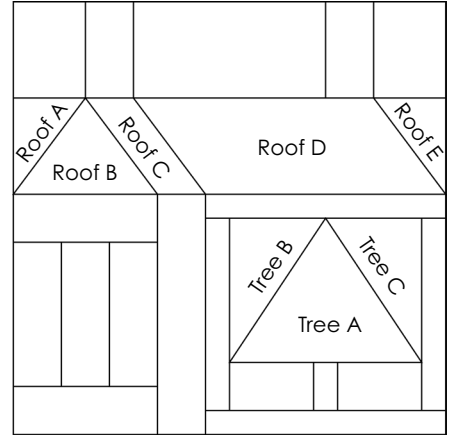



CHRISTMAS VILLAGE TEMPLATES

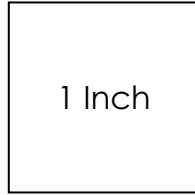
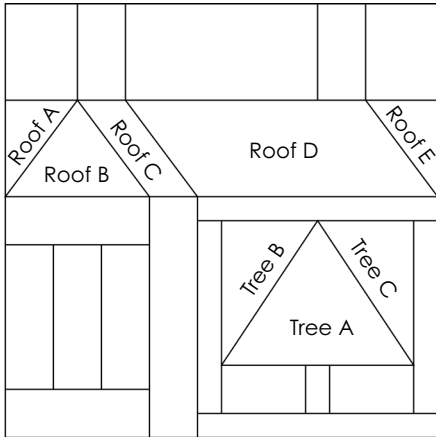

Print at 100% or
Actual Size

