

michael miller FABRICS

ON THE TIDE

SIZE: 52-1/2" x 68-1/2" • LEVEL: INTERMEDIATE • PATTERN BY: MARSHA EVANS MOORE



THIS IS A DIGITAL REPRESENTATION OF THE QUILT TOP, FABRIC MAY VARY.

PLEASE NOTE: BEFORE BEGINNING YOUR PROJECT, CHECK FOR ANY PATTERN UPDATES AT MICHAELMILLERFABRICS.COM'S FREE PROJECTS SECTION.

p.212.704.0774 | info@michaelmillerfabrics.com | www.michaelmillerfabrics.com

ON THE TIDE

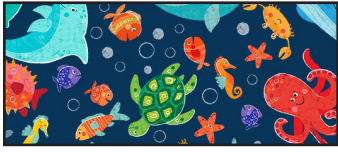

FABRIC A
DC9558_Navy
3/4 yard



FABRIC B
DC9559_Water
1/2 yard

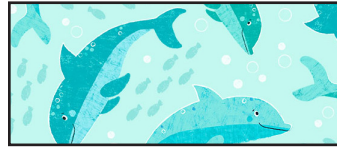

FABRIC C
DC9560_Aqua
1/3 yard

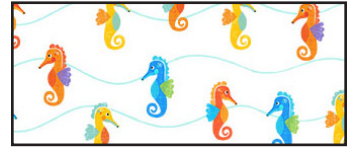

FABRIC D
DC9561_White
1/3 yard



FABRIC E
DC5963_White
3/4 yard



FABRIC F
DC9564_Aqua
3/8 yard

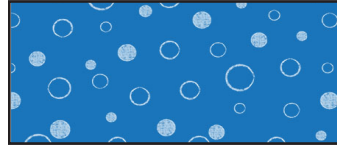

FABRIC G
DC9564_Blue
1/4 yard

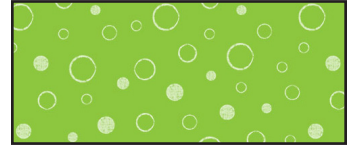

FABRIC H
DC9564_Lime
1/4 yard

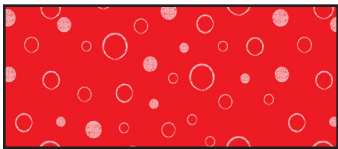

FABRIC I
DC9564_Red
7/8 yards



FABRIC J
DC9564_Yellow
1/4 yard



FABRIC K
DC9565_Blue
1/2 yard



FABRIC L
SC5333_softwhite
5/8 yard

KEY	CUTTING INSTRUCTIONS
A	(6) 3-1/2" x 42" strips; sew ends together. Subcut (2) 3-1/2" x 64-1/2" borders and (2) 3-1/2" x 54-1/2" borders.
B	(2) 8-1/2" x 42" strips; subcut (5) 8-1/2" squares.
C	(1) 8-1/2" x 42" strip; subcut (4) 8-1/2" squares.
D	(1) 8-1/2" x 42" strip; subcut (4) 8-1/2" squares.
E	(6) 2-1/2" x 42" strips; sew ends together. Subcut (2) 2-1/2" x 58-1/2" borders and (2) 3-1/2" x 48-1/2" borders. (1) 8-1/2" x 42" strip; subcut (4) 8-1/2" squares.
F	(3) 2-1/2" x 42" strips; subcut (8) 2-1/2" x 6-1/2" rectangles, (8) 2-1/2" x 4-1/2" rectangles and (8) 2-1/4" squares.
G	(1) 4-1/2" square.
H	(2) 2-1/2" x 42" strips; subcut (6) 2-1/2" x 6-1/2" rectangles, (6) 2-1/2" x 4-1/2" rectangles and (6) 2-1/4" squares.
I	FOR BINDING: (7) 2-1/4" x 42" strips, trim ends diagonally. Sew short ends together. (2) 4-1/2" x 42" strips; subcut (17) 4-1/2" squares.
J	(2) 2-1/2" x 42" strips; subcut (4) 2-1/2" x 6-1/2" rectangles, (4) 2-1/2" x 4-1/2" rectangles and (4) 2-1/4" squares.
K	(13) 1-1/2" x 16" LOF strips (perpendicular to stripes), sew ends together. Subcut (2) 1-1/2" x 43-1/2" borders and (2) 1-1/2" x 59-1/2" borders; trim ends diagonally.
L	(2) 2-7/8" x 42" strips; subcut (18) 2-7/8" squares. (4) 2-1/2" x 42" strips; subcut (54) 2-1/2" squares.

ADDITIONAL MATERIALS

3-1/2 yards backing fabric

62-1/2" x 78-1/2" batting

Thread to match fabrics

Black thread or embroidery floss for eyes

Paper to print paper piecing patterns

ON THE TIDE

BLOCKS

1. Paper piece the shapes on the claw patterns in numerical order using **L** and **I** fabrics. Make right and left claw units. Make 1 each.

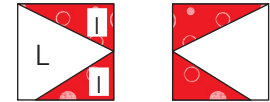

Make 1 each

2. Paper piece the shapes on the leg patterns in numerical order using **J** and **I** fabrics. Make right and left leg units. Make 1 each.



Make 1 each

3. Draw diagonal lines on the wrong side of (1) **L** 2-7/8" square and (1) **J** 2-1/4" square.



4. Place (1) **L** 2-7/8" square on the upper left corner of (1) **I** 4-1/2" square. Sew along the drawn line. Trim the fabric 1/4" from the stitching as indicated by the solid line. Press the **L** piece open.

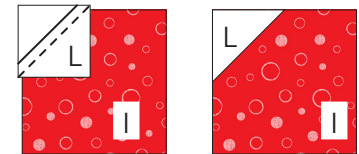

5. Place (1) **J** 2-1/4" square on lower right corner of the **I** 4-1/2" square. Sew along the drawn line. Trim the fabric 1/4" from the stitching as indicated by the solid line. Press the **J** piece open to complete the body unit. Trace 7/16" diameter eyes to body. Embroider by hand or machine using black thread or floss. Make 1.

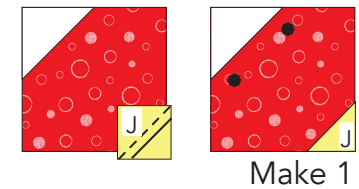

6. Sew each claw unit to (1) **L** 2-1/2" square.



Make 1 each

7. Arrange (1) **L** 2-1/2" square, (2) claw units, (2) leg units, (1) body unit, (1) **J** 2-1/2" x 4-1/2" rectangle and (1) **J** 2-1/2" x 6-1/2" rectangle in 3 rows. Sew the pieces in each row together.

8. Sew the rows together matching seams. The block should measure 8-1/2" square including seam allowance.

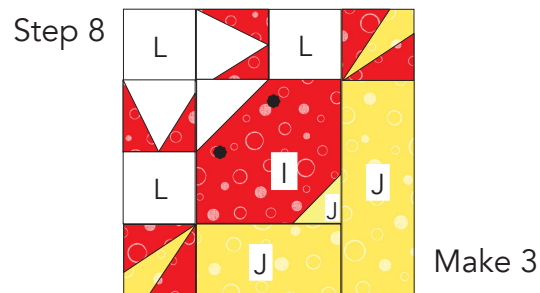
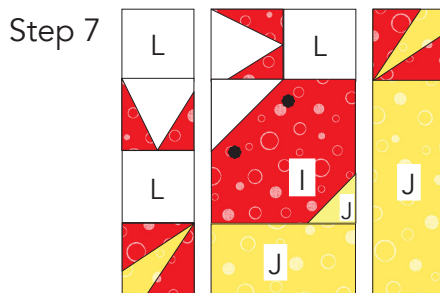

9. Follow steps 1-8 to make blocks using the fabrics shown. Make the number of blocks indicated.

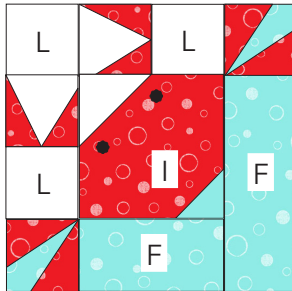

Make 8

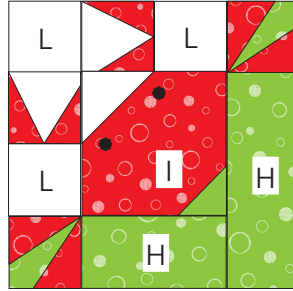

Make 6

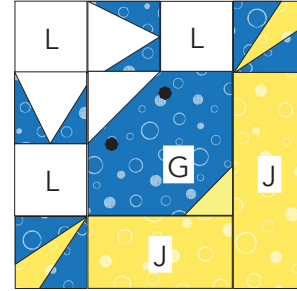

Make 1

10. Arrange (18) blocks, (5) **B** 8-1/2" squares, (4) **C** 8-1/2" squares, (4) **D** 8-1/2" squares and (4) **E** 8-1/2" squares in (7) rows of 5 blocks and squares as shown on the Quilt Layout on page 5.

Sew the blocks and squares in each row together.

11. Sew the rows together matching seams.

12. Sew (1) **K** 1-1/2" x 59-1/2" border to sides of quilt center beginning and ending stitching 1/4" from ends of fabric. Sew (2) **K** 1-1/2" x 43-1/2" borders to the top and bottom of the quilt center beginning and ending stitching 1/4" from ends of fabric. Sew borders together along diagonal ends.

13. Sew (1) **E** 2-1/2" x 58-1/2" border to sides of quilt. Sew (2) **E** 3-1/2" x 48-1/2" borders to top and bottom of quilt.

14. Sew (1) **A** 3-1/2" x 64-1/2" border to sides of quilt. Sew (2) **A** 3-1/2" x 54-1/2" borders to top and bottom of quilt.

FINISHING: Layer quilt top, batting and backing together to form quilt sandwich. Baste and quilt as desired. Bind using nine fabric **I** 2-1/4" strips.

ON THE TIDE

Quilt Layout



Paper Piecing Patterns

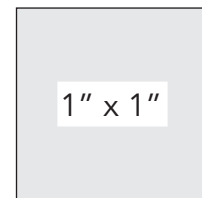
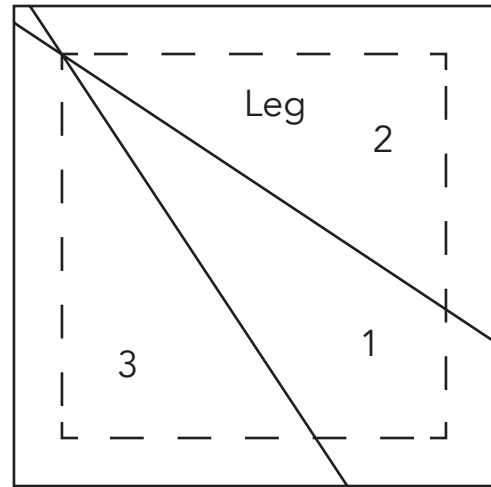
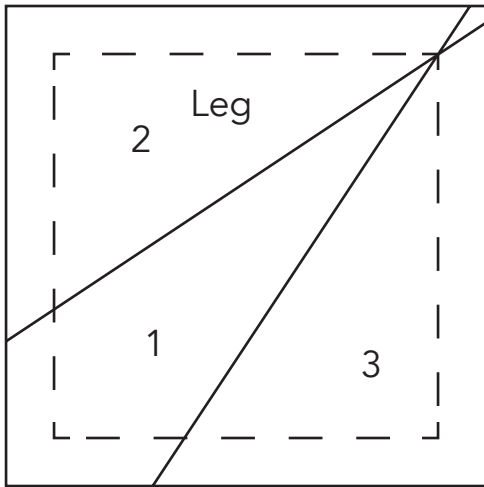
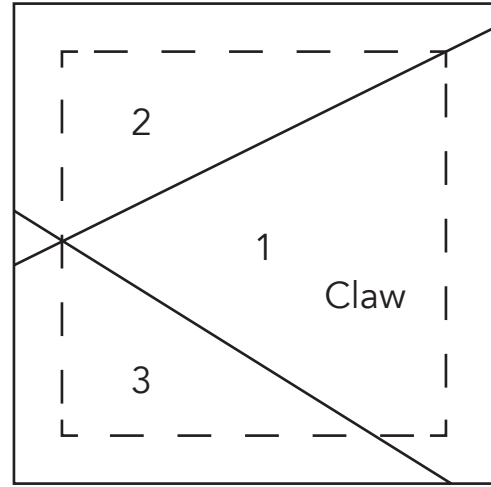
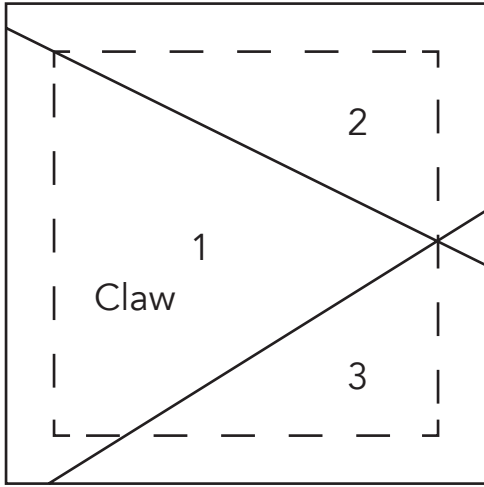

Print at 100%.