

Chevron Kaleidoscope

Quilt Designed by Emily Herrick



Size: 50" x 60"

Skill Level: Intermediate



FABRIC REQUIREMENTS



CX6222 SPAX
Chevy
4 1/4 yards



SC5333 CHAR
Cotton Couture
2 1/8 yard

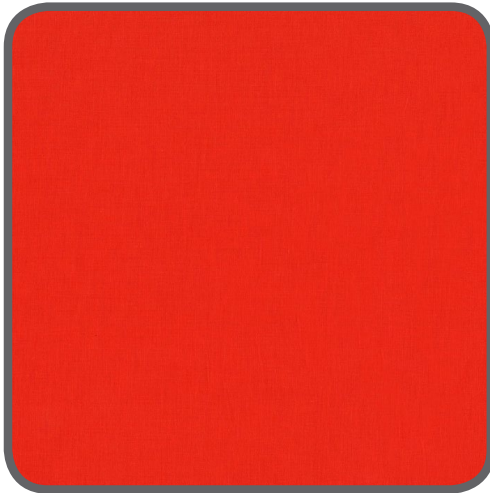

SC5333 CLEM
Cotton Couture
1 yard

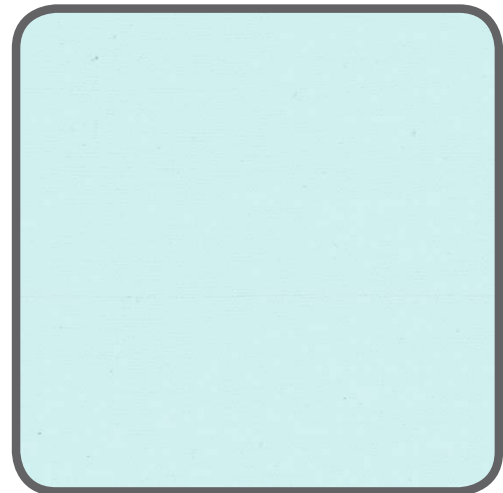

SC5333 SPA
Cotton Couture
1/8 yard

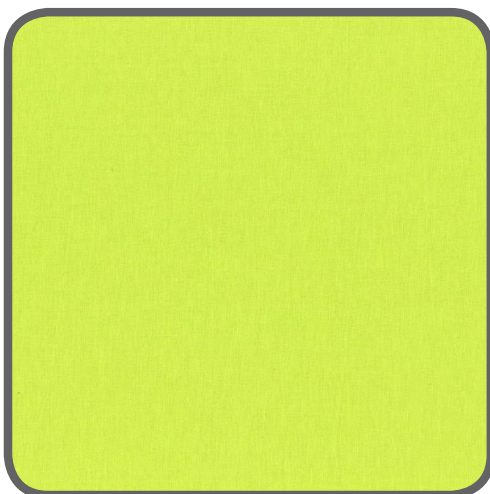

SC5333 LIMEADE
Cotton Couture
1/8 yard

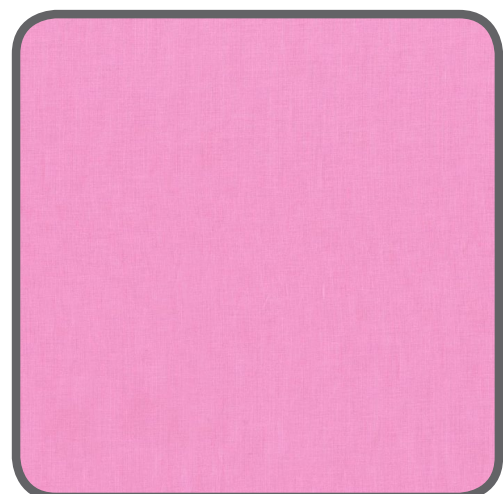

SC5333 PINK
Cotton Couture
1/8 yard

"Chevy Kaleidoscope"

Quilt by Emily Herrick

Size: Approximately 50" W x 60" H Skill Level: Intermediate

Materials

Fabric	Yardage	Cutting
CX6222 Spax Chevy	4 1/4 yards	Fussy cut Dresden pieces
SC5333 Char Cotton Couture	2 1/8 yards	(4) 20 1/2" x 20 1/2"; (10) 10 1/2" x 10 1/2"; 4" squares for Dresden centers
SC5333 Clem Cotton Couture	1 yard	(1) 20 1/2" x 20 1/2"; Remaining fabric cut to 2 1/2" strips for Binding
SC5333 Spa Cotton Couture	1/8 yard	4" squares for Dresden centers
SC5333 Limeade Cotton Couture	1/8 yard	4" squares for Dresden centers
SC5333 Pink Cotton Couture	1/8 yard	4" squares for Dresden centers

Also needed: lightweight fusible interfacing (1/2 yd) 52" x 70" backing, 52 x 70" batting, threads to match, scissors, straight pins, rotary cutter, acrylic ruler, and mat.

*** *REQUIRED:** Easy Dresden Ruler by Darlene Zimmerman

Disclaimers

This pattern is provided as a courtesy to quilt stores, catalogs, and quilters. Michael Miller Fabrics, LLC is not responsible for the accuracy of any kits packaged to accompany this pattern. Please direct any inquiries to the kit maker.

Yardage requirements for this pattern may allow for excess yardage to accommodate specific placement of motifs or to allow for any fussy-cutting to achieve the finished quilt design.

While every attempt has been made to give accurate measurements, yardage requirements, and construction directions; this does not allow personal variations in measuring, cutting, and or sewing. The enclosed directions were used in the construction of the original quilt.

Directions

1. Press the Chevron fabric and starch well as prep for cutting.
2. Cut a 30" x WOF piece from the Chevron fabric. Reserve for step 16.
3. Align a long ruler with the chevron points on the fabric to cut the fabric into lengthwise strips. It is more important for the chevron motif to be aligned than to have the fabric strip perfectly straight. This will ensure continuity when fussy cutting the Dresden shapes.



3. Cut (3) 8" x length of fabric (LOF) and (3) 3" x LOF. Reserve remaining fabric.

4. Begin cutting pieces using the Easy Dresden ruler.
5. Align the ruler over a motif on the fabric. Make sure the zig or zag is in the center of the ruler. Make a mental note of where it is and carefully cut on the left and right side of the ruler [1].
6. Slide the Dresden ruler to the right and align so that the same motif as the first piece is centered under the ruler. Cut on the left and right side [2]. You now have 2 wedges for the first dresden. Stack together.

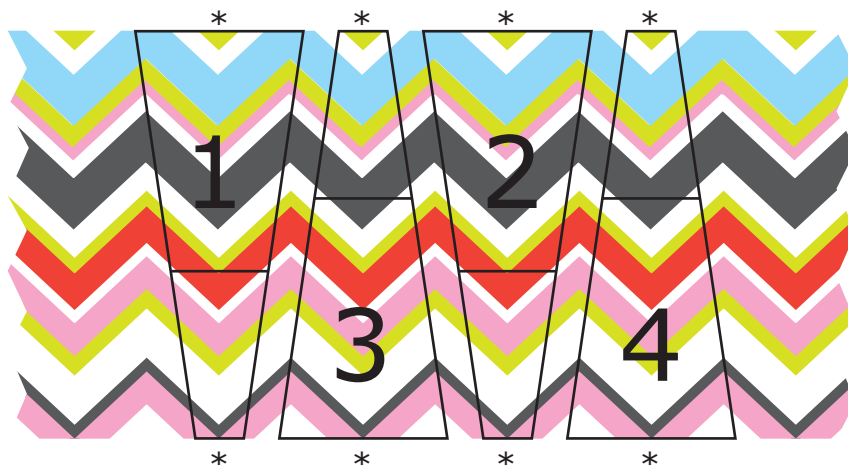

7. Next, turn the ruler around and place on the fabric between the two wedges just cut.
8. Align the ruler making sure the point of the zig zag is centered. Cut [3].
9. Move the ruler along the fabric strip and cut out the next wedge [4].
10. Follow this same method along the fabric strip.
11. Cut 20 identical pieces for each Dresden. (1 fabric strip = wedges for 2 Dresden blocks.)
12. Repeat this process for (2) 8" x LOF strips.
13. On the third 8" fabric strip you will cut 20 identical wedges for the final 8" Dresden block and 5 identical wedges for a fan block.
14. Repeat this process of cutting with the 3" x LOF fabric strips lining up the 3" mark on the ruler.

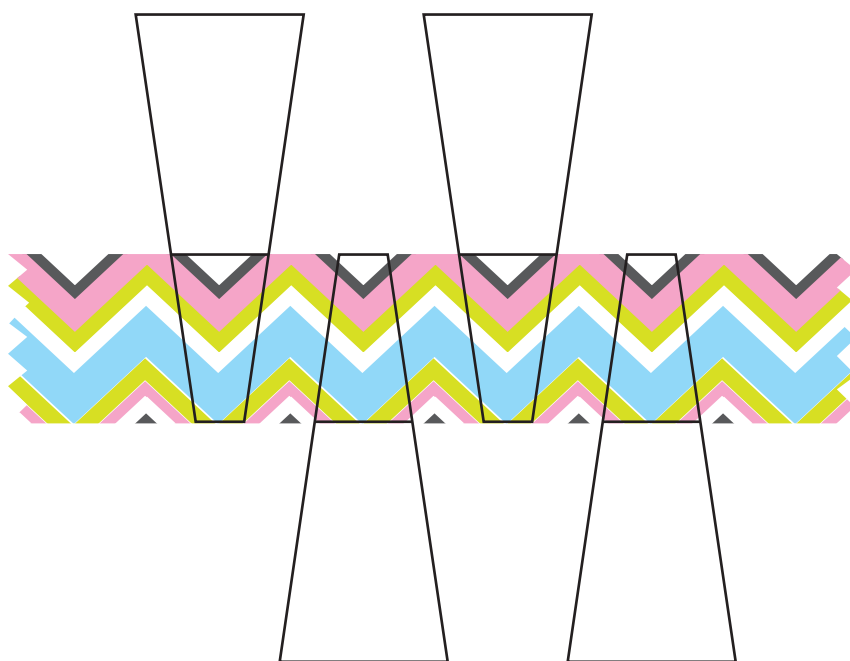

15. Cut enough identical pieces for each of the (5) 8" Dresden blocks [20 pieces in each], (5) 3" Dresden blocks [20 pieces in each] and (5) 8" fans [5 pieces in each].

16. Cut the reserved fabric into 8" x LOF strips for the remaining fan blocks. This gives you the opportunity to align the ruler in a different place for each fan creating a completely different look for each block.

17. Once all the wedges for each Dresden have been cut you can start assembling the blocks.

18. Fold the top edges of the wedge, right sides, together. Using a short stitch length, stitch 1/4" from the edge. Clip the folded corner and finger press seam open.

Turn the point and press with the seam centered on the wedge. Repeat for each wedge.

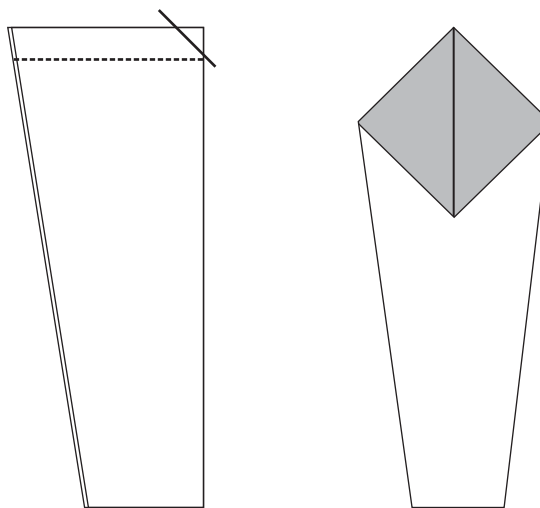

19. Begin sewing the wedges together using an exact 1/4" seam. Handle all the pieces gently, as they have bias edges. Press the seams all one direction around the circle or quarter circle being careful not to stretch or skew the pieces.

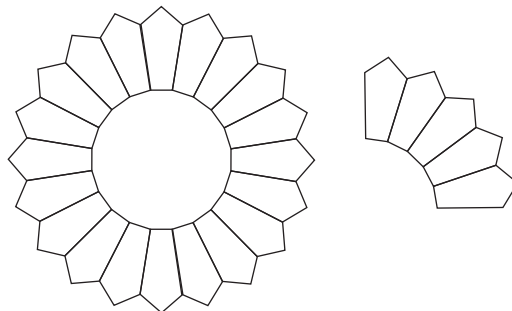

20. Pair each 8" Dresden plate with a 20 1/2" background square. Four blocks will have charcoal backgrounds, one will have a clementine background. Each of the five 3" Dresden plates and 8" Dresden fans will have 10 1/2" charcoal background squares.

21. Fold each background square in quarters and lightly press the corner fold. This will be a reference point for centering the Dresden plates.

22. Center each Dresden plate on its respective background square and generously pin in place. Top stitch 1/8" from the edge to secure to the background. Top stitch just inside the center as well. Repeat for each Dresden plate block.

23. Align each fan with the sides of its background square. Pin in place and top stitch as before.

24. (15) 3 1/2" circles on the lightweight interfacing. Cut out each circle leaving a 1/4" seam allowance. Pair with a colored 4" square for each block.

25. Place the interfacing, fusible side toward the right side of the fabric. Stitch on the marked line. Trim 1/8" from stitched edge. Cut a slit in the interfacing and turn. Finger press edges to form fabric circle.

26. Center each circle on its respective Dresden block. Press in place. Stitch in place using a narrow zig zag stitch just catching the edge of the circle.
27. Pin each circle in place on the fan blocks. Trim to align with the block edges. Press in place and stitch 1/8" from the block sides to secure. Zig zag stitch the curve of the circle as done on the Dresden blocks.
28. Lay blocks out as shown in the Quilt Assembly diagram.
29. Stitch 10 1/2" blocks together in pairs where needed, then sew to larger blocks. Assemble quilt in sections, then sew sections together to complete quilt top.
30. Layer backing, batting and quilt top. Baste.
31. Quilt as desired.
32. Join binding strips together as needed. Bind.

QUILT ASSEMBLY DIAGRAM

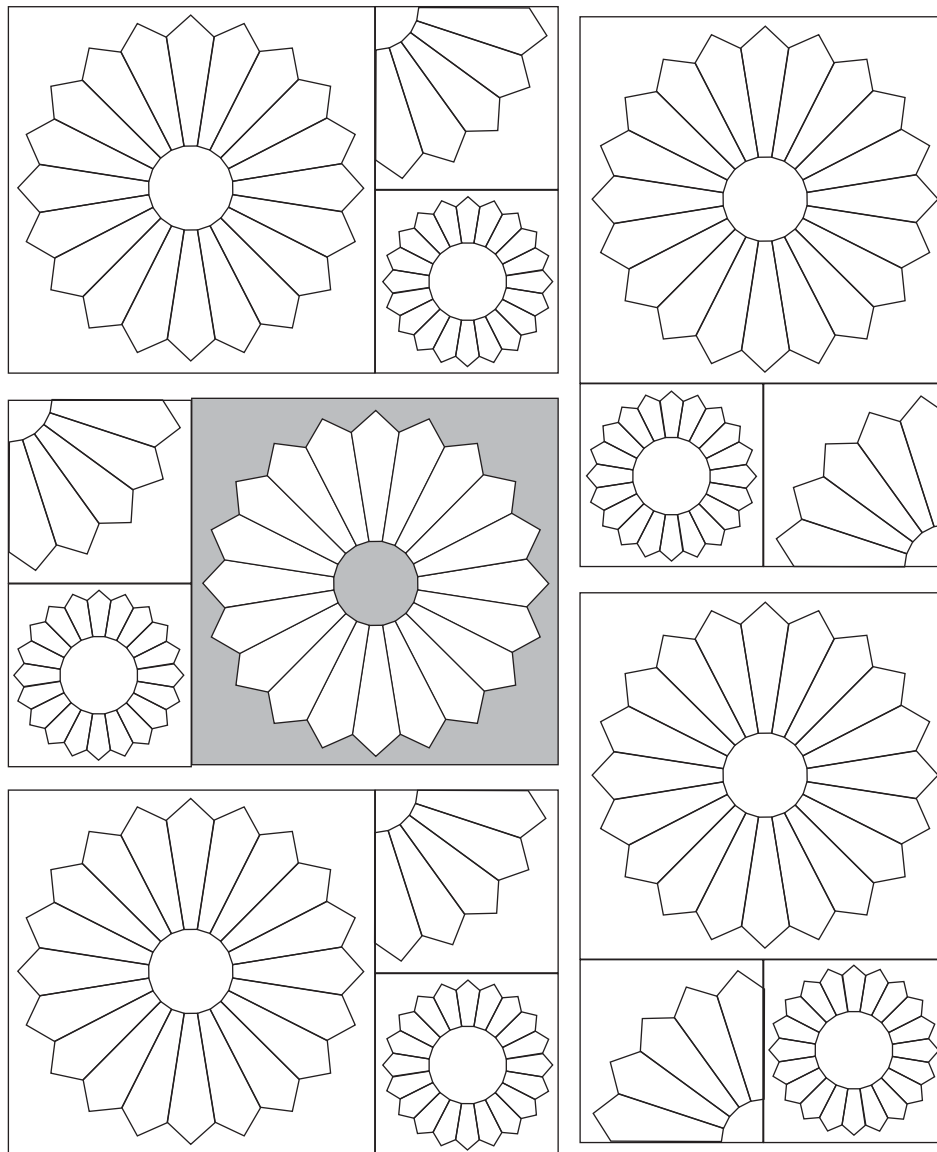

Disclaimer

This pattern is provided as a courtesy to quilt stores, catalogs, and quilters. Michael Miller Fabrics, LLC is not responsible for the accuracy of any kits packaged to accompany this pattern. Please direct any inquiries to the kit maker.

Yardage requirements for this pattern may allow for excess yardage to accommodate specific placement of motifs or to allow for any fussy-cutting to achieve the finished quilt design.

While every attempt has been made to give accurate measurements, yardage requirements, and construction directions; this does not allow personal variations in measuring, cutting, and or sewing. The enclosed directions were used in the construction of the original quilt.